

# The SHORT WAVE Magazine

VOL. XXV

MAY 1967

NUMBER 3

## KW 201 *High quality - low price* AMATEUR BANDS COMMUNICATIONS RECEIVER

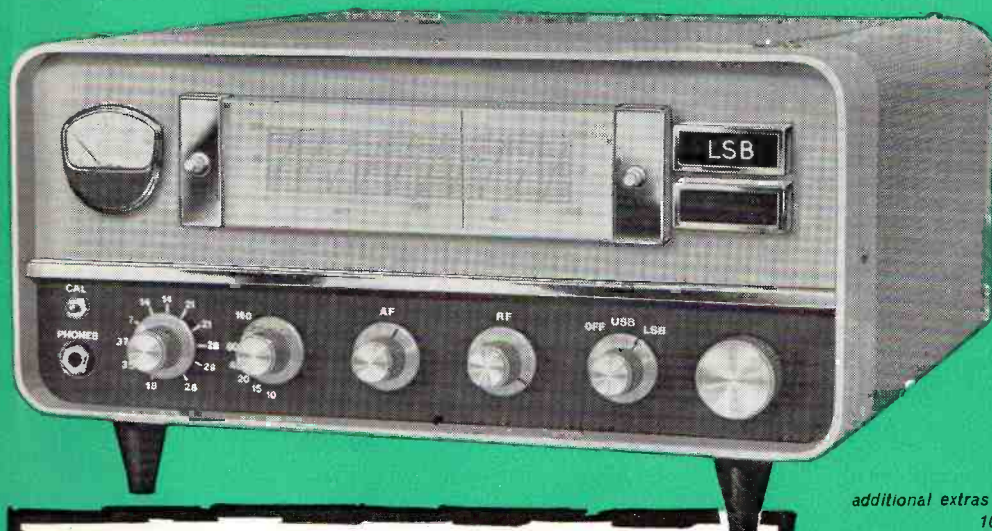

The KW 201 has been specifically designed for optimum performance on Single Sideband. 11 ranges give coverage in the amateur bands from 1.8 mc/s. to 30 mc/s. A mechanical filter gives an I.F. selectivity of 3.1 kc/s. at 6 d.b., and 6 kc/s. at 60 d.b. A 'Q' multiplier is available giving a variable range of 3.1 kc/s. to 200 cycles selectivity.

### £105

BASIC PRICE

additional extras if required

100 kc/s Crystal Calibrator £6. 0.0

'Q' Multiplier £8.10.0

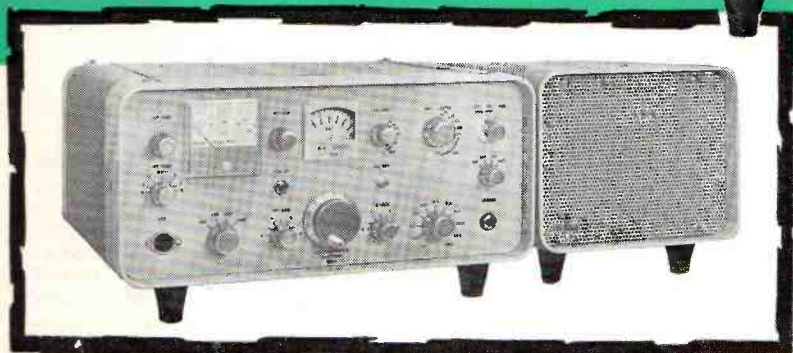

### KW 2000A TRANSCEIVER

180 watt P.E.P. operation on all amateur bands 10-160 metres, complete with A.C. power supply **£220** inclusive

ALSO AVAILABLE FROM STOCK

**KW VESPA** transmitter, 10-160 metres SSB, AM and CW complete with AC PSU £120.00

**KW600** linear amplifier, 500w P.E.P. 572B tube built-in power supply £110.00

Exclusive U.K. agents for DAVCO and HAMMARLUND equipment.

Agents for Sommerkamp equipment, Collins, Drake, (2c receiver available) Swan, Mosley, Hy-gain, CDR, Kokusai mechanical filters, Tokai walkie talkies. Microphones, co-axial cable and all your amateur radio equipment always in stock

The leading supplier for the Amateur Radio Market  
**K. W. ELECTRONICS LTD.**

1 HEATH STREET . DARTFORD . KENT  
Phone: Dartford 25574. Cables: Kaydublew, Dartford

CONTACT YOUR LOCAL DISTRIBUTOR  
AGENTS IN MANY COUNTRIES  
DIRECT SHIPMENTS MADE ALL OVER THE WORLD

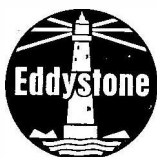

# Eddystone EA 12

## Amateur communication receiver

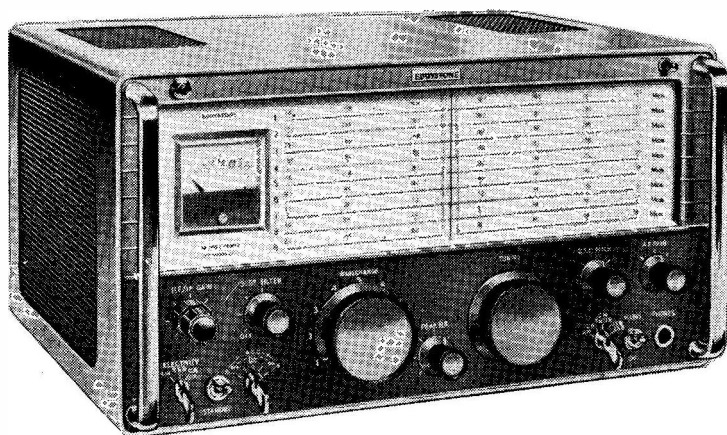

An amateur bands double-conversion superheterodyne receiver, for a.m, c.w. and s.s.b reception. For all amateur channels between 1.8 MHz and 30 MHz in nine 600 kHz bands with 28 MHz to 30 MHz in four bands.

**Primary features.** Crystal controlled 1st oscillator, 2nd oscillator with continuously variable selectivity to 50 Hz, muting switched or by external relay, twin noise limiters, for a.m/c.w, and s.s.b, short-term drift better than 20 Hz and less than 100 Hz in any one hour, 'S' meter calibrated in nine levels of 6 dB and dB levels beyond 'S9,' two a.g.c time constants, deep slot filter, independent r.f, i.f, and audio gain controls with outputs for f.s.k and panoramic adaptor. **£185.**

### OTHER RECEIVERS IN THE FAMOUS EDDYSTONE RANGE

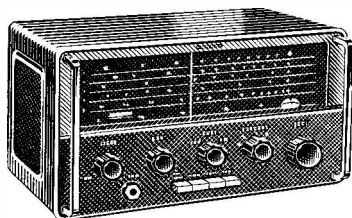

#### EC10 communications receiver

The fully transistorized EC10 communications receiver, supreme in its class, covers both medium wave broadcasting and all shortwave service to 30 MHz. Incorporating the famous Eddystone tuning drive, with logging scale and auxiliary vernier, shortwave reception is particularly simple. Battery operated or from optional a.c mains unit. **£48.**

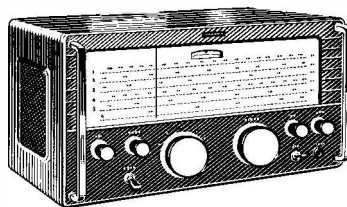

#### 840C A.C or D.C communications receiver

An 8-valve receiver with gap free coverage from 600 to 10 metres providing excellent reception of broadcast programmes and all major s.w channels including marine and international distress frequencies. The famous Eddystone extended band spread and logging scale is an essential feature. Suitable for a wide range of a.c and d.c voltages. Fully tropicalized. **£66.**

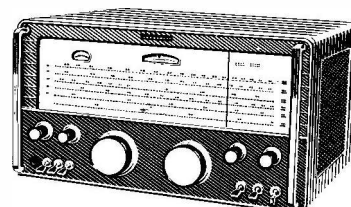

#### 940 13-valve high sensitivity receiver

A superb high performance receiver incorporating two r.f and two i.f stages, push-pull output and silicon diode noise limiter circuit. Gap free coverage from 480 kHz and suitable for reception of c.w, a.m, and s.s.b modes. Exceptional sensitivity and stability. Built to professional standards for the serious listener. **£133.**

**Comprehensive information from your Eddystone distributor or from: Eddystone Radio Limited, Eddystone Works, Alvechurch Road, Birmingham 31. Telephone Priory 2231. Telex 33708**

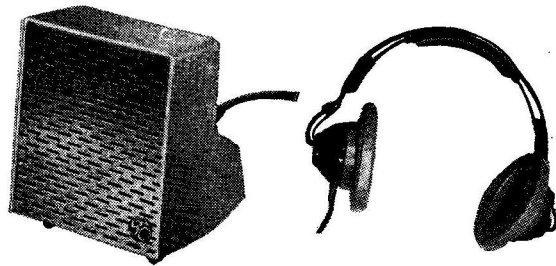

1

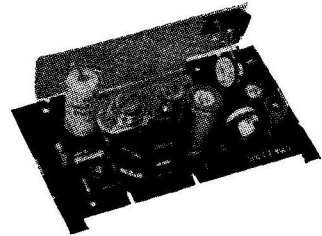

2

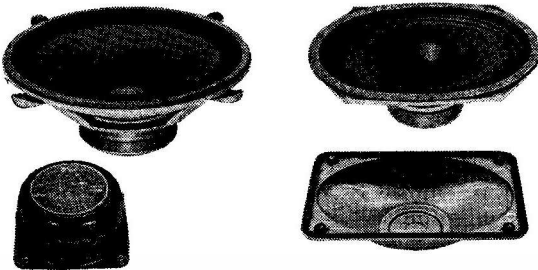

3

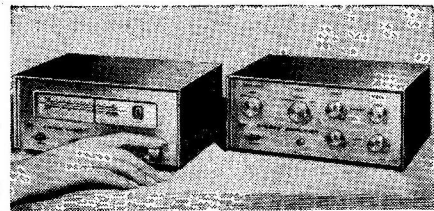

4

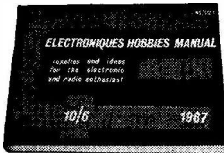

I should like a copy of the Electroniques Hobbies Manual. Enclosed is a cheque/P.O. for 10/6.

NAME \_\_\_\_\_

ADDRESS \_\_\_\_\_

SW6

## Audio is just one of the topics covered in the Electroniques Hobbies Manual

With the new 600-page Electroniques Hobbies Manual, you can obtain these and over 11,350 other items—either direct from Electroniques or through your local Electroniques dealer! The service is fast. The choice is the most comprehensive ever offered. And the components, which are supplied by 85 leading manufacturers, meet every kind of need—whether the project is advanced or elementary.

**1. COMPONENTS** A wide range of individual components is available. These include microphones, headsets, pickup arms, cartridges and styli. Hardware accessories such as audio connectors, transformers and microphone stands are also available. Featured above are the STC 4114 microphone price 32/6 and the STC 65/1A Stereo headset at £7.7.0. Both plus 3/6d. post and packing.

**2. MODULAR UNITS** Featured above is the GMA20 audio amplifier module having a music power rating of 15 watts. This is one of a range of modular units including microphone amplifiers, audio amplifiers, modulators and tuners. Price of the GMA 20 is 82/6d. plus 3/6d. post and packing.

**3. KITS** This 25 watt Hi-Fi Loudspeaker kit is manufactured by our associates in Germany, and fulfils the highest standards. Supply direct from the factory enables us to offer these magnificent kits at the modest price of £7.10.3. plus 3/6d. post and packing.

**4. COMPLETE EQUIPMENT** A range of complete equipments is also available, and among these are included microphone mixers, pre-amps, tuners and stereo amplifiers. In the illustration are the Eagle Stereo Amplifier, price £18.5.0. and the Eagle AM/FM tuner, price £28.17.9. Both plus 3/6d. post and packing.

**DESIGNS** Throughout the Hobbies Manual are useful designs for building your own equipment. Included are circuit diagrams and details for audio amplifiers, tone controls, tape recorders and pre-amps.

For the 600-page Electroniques Hobbies Manual or further details of the products displayed on this page write to: Electroniques (Prop.STC) Ltd., Edinburgh Way, Harlow, Essex. Telephone: Harlow 26777.



High-grade components for amateur communications

# FET CONVERTERS

for

**2 metres £16**

**4 metres £16**

**70 cm. £18**

post and packing 3/9

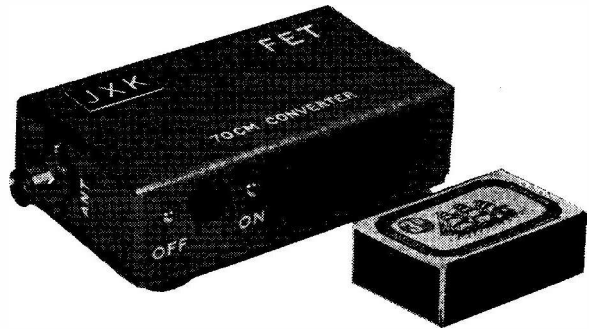

These converters have a built-in mains power supply, out-perform valve converters in every way, and have the very great advantage that they simply require 9/12 volts at 16 ma. for portable and mobile work. The FETs ensure great freedom from cross-modulation and blocking being at least 20 dB better than valves in this respect.

## JXK CONVERTERS

PEEL HOUSE, PORTERS LANE, OSPRINGE, FAVERSHAM, KENT

# SWAN

STILL THE MOST RELIABLE TRANSCEIVER EVER MANUFACTURED!

BIG SIGNAL — UP TO 500w. P.E.P., 325w. C.W., 125w. A.M.

Sideband suppression :  
> 40 dB.

Carrier suppression :  
> 50 dB.

Filter Shape Factor :  
1.7-1 6-60 dB.

Selects correct sideband  
for band in use.

Dual ratio silk smooth  
tuning.

FULL coverage of all  
bands 80-10 metres.

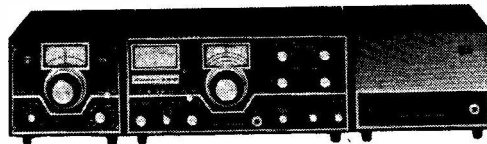

Shown with remote V.F.O. giving full "band in use" split frequency working (not just a few Kc/s.) or the same facilities as two separate transceivers. Basic transceiver with A.C. power unit/speaker £250

Full range of accessories :

100 Kc. calibrator kit £9. 10

Opposite sideband kit £8. 15

Transistor V.O.X. ... £16. 0

Remote V.F.O. with 22 adaptor for up to 200 Kc. split frequency working ... £50. 0

Remote V.F.O. with 22 adaptor for full band split frequency working ... £57. 0  
(As illustrated)

D.C. P.S.U. to be used with 230XC power unit (as supplied with transceiver) ... £33. 0

First class after sales service.  
Immediate delivery.  
Top trade-in allowances.  
Latest brochures on request.

See them in stock at your local agents :

LONDON : Philadelphian Electronics, 188 Broadhurst Gardens, N.W.6.

SCOTLAND : L. Hardie, 542 George Street, Aberdeen.

**PETER SEYMOUR LIMITED**  
410 BEVERLEY ROAD, HULL, YORKSHIRE

Telephone: 41938 (43353 after 7.30)

# J. B. LOWE

51 Wellington Street, Matlock, Derbyshire  
Tel.: Matlock 2817 (or 2430 evenings)

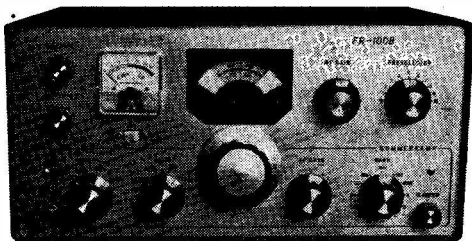

**FR-100-B Rx.** 80-10, mechanical and crystal filters, 4, 2:1 and 0.5 kc/s. Better than  $\frac{1}{2}$  UV for 10 dB S/N. **£112.0.0**

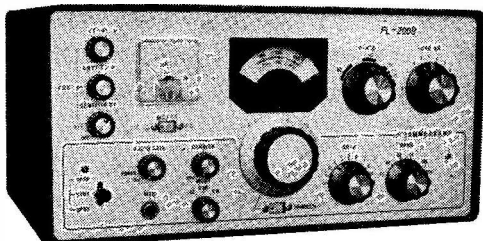

**FL-200-B Tx.** AM/CW/SSB. 240W. p.e.p., 100W AM. VOX, PTT, Break-in CW. Sidetone monitoring. Connectors for transceiver with the FR-100-B supplied. Note:—The 6JS6A finals are the same electrically as the 6HF5 so the power ratings are conservative. **£130.0.0**

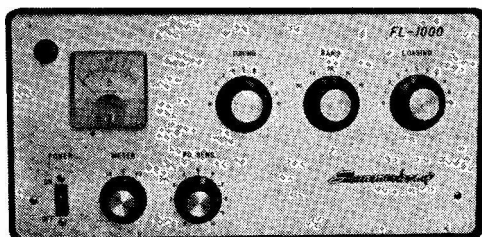

**FL-1000 Linear.** 4-6JS6A's. 960W. input. **£90.0.0**

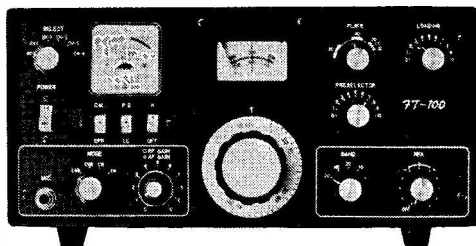

**FT-100 Transceiver.** 150W p.e.p. all transistor except driver and P.A. 13" x 6" x 10" deep. **£180.0.0**

FULL DETAILS ON REQUEST

Feeling in a writing mood, I thought I would just ramble on this month instead of just setting out a list of stuff. I like this writing bit—probably some deep psychological urge—schizo Willie! Maybe I should try talking our favourite Ham periodical into letting me do a column. It could be called "Bandit Bill's Bit" or, if decorum is required, "Obiter Dictum" and if any of you ignorant lot don't speak Latin—"Obiter" one who obits, "dictum" from the famous saying of Caesar "ump, ump, dictum upia jumpa." Ah well, if you were trying to work Dx on 80 you'd be nutty as a fruit cake, too!

Incidentally, who started this rumour about the Sommerkamp FT-100 being withdrawn? They may be right of course, but strange that I haven't heard anything officially. Even stranger is that I have continued to get deliveries and by the time this appears my next batch will be about due and subsequent batches every month. Very odd. Talking of this so-called cheap Jap junk, the report in the Bulletin will settle it once and for all. A very fair, unbiased report on the Sommerkamp line which bears out what I've been telling you, that Sommerkamp is the best value for money. If someone will produce something as good at the same price I will be very happy to sell it, but in the meantime I'll stick to Sommerkamp. Incidentally, at the time of writing I have eight linears, 16 transmitters and 22 receivers in stock. The disadvantages and imperfections are really negligible when compared to the good points—figure it out for yourselves, lads, and if anyone can show me better value I'll eat my hat. For those who do want something better, Collins and Racal make quite good stuff I believe! If you don't want to go as high in price for a Rx as the FR-100-B, the Lafayette HA350 at 75 gns. is a winner. In fact I like a lot of the Lafayette stuff and what I like, I sell. Conversely, of course, what I don't like I don't sell! I suppose that if I had any sense I would sell the stuff that gives me the biggest profit margin, but I would rather sell something that I know is going to make my Customers happy rather than have them come back complaining. Maybe I'm not so daft after all!

Anyway, just to show how unbiased I am, another winner in its price class is the RAI which I don't stock, not because I don't want to, but I'm not a Heathkit Agent. When properly aligned it takes a bit of beating for the money. Please note though that I say "when properly aligned."

I have ordered the new Lafayette 500 and 700 which should be pretty good, but I'll let you know when I've had a chance to try them out. If I honestly feel they are value for money I will flog 'em.

I haven't left myself much space for stock this month—actually though, it's a bit of a dead loss because I am writing this advertising copy in March and by the time you see it my stock will have changed anyway! Always the way—you see something you've been after a long time, just what you want, cheap too. You 'phone the minute you see the ad, but almost invariably it's been sold. Ain't it the truth, though! You can't win! The thing to do is to drop me a line telling me what you want. If I've got it, fine and dandy, but if I haven't, Jean, who does all the office work, will put your name down in her little book and you get first refusal of anything that comes in. May I just warn you, though, that the waiting list for mint all band SSB rigs at around £20 is rather long. Man, I'll do my honest best for you, but I'm no magician!!! Anyway, I have a pretty fair stock of stuff of all types and a s.a.e. will get you the latest list. I make no extravagant claims pertaining to absolute bargains—you know the sort of thing, "Unbelievable value! A huge bulk purchase enables us to offer the super de luxe blah blah at the incredible price of £9 19s. 11d. Waste no time, buy now before prices go up." If prices were going up I would be inclined to keep quiet until they did, then flog 'em! No, you won't get any stuff at an incredible price at Bill Lowe's, but you will get fair play.

I also buy and will give you a fair price for stuff which I can sell—which I myself recommend in my ads. and other good stuff such as HRO's, AR88's, SP600's, etc., etc.

If you are thinking of a sideband transceiver, drop me a line. By the time you see this, I may (if all goes well) be able to give you a very good deal on a top quality rig. Early days, but I think I have another winner coming up!

Best of DX es 73 de Bandit Bill

G3UBO/VE8DP.

## DIPLOMATIC WIRELESS SERVICE

has vacancies for

# RADIO TECHNICIANS

The Diplomatic Wireless Service operates a world-wide network of radio stations providing communications and technical services for H.M. Diplomatic Service and the Overseas Information Services.

Its functions include :—

1. The construction and operation of radio communications transmitting and receiving stations in the United Kingdom and overseas (some 70 stations).
2. The construction and operation of radio broadcast relay stations handling B.B.C. Overseas Services.
3. The installation and maintenance of telephone and teleprinter systems and other technical equipment in the United Kingdom and at Diplomatic Missions overseas.
4. The design, development and manufacture of equipment used by the Department.

Radio Technicians are employed on a range of duties associated with the functions mentioned above.

Candidates, who should normally be at least 19 years of age, should have a sound knowledge of radio or telephony and preference will be given to candidates who have 'O' Level passes in G.C.E. in English, Mathematics and Physics or who hold the City and Guilds Intermediate Certificate in Telecommunications Engineering or an equivalent or higher technical qualification.

Selected candidates, who will have a liability for overseas service and shift work, will be required to undergo medical examination. Initial appointments will be at Hanslope Park, Gawcott and Creslow, Bucks., or Crowborough, Sussex.

Commencing salary according to age ; for candidates aged 25 and over starting salary £962 per annum on a scale rising by annual increments to £1,104 per annum.

Subject to satisfactory service Radio Technicians with appropriate qualifications are considered for entry into the Telecommunications Technical Officer Class.

Candidates and both their parents must have been British subjects at all times since birth.

Applications giving age, qualifications and experience and quoting reference RT/1 should be addressed to :—

**The Personnel Officer,  
Diplomatic Wireless Service,  
Hanslope Park,  
Wolverton,  
Bucks.**

## HOME RADIO (Mitcham) LTD. 187 London Road, Mitcham, Surrey, CR4 2YQ. 'Phone: MIT 3282



The Eddystone EC 10 is a transistorised Communications Receiver operating from six U2 cells (a mains unit is available). Gives continuous coverage from 550 Kc to 30 Mc/s. £48. (H.P. Terms available.) Send for free brochure.

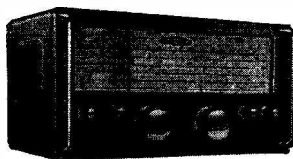

The Eddystone 840C is an 8-valve Superhet covering from 480 Kc to 30 Mc/s in 5 ranges. For A.C. mains operation. A fine receiver at a moderate price, £66. (H.P. Terms available.) Send for free brochure.

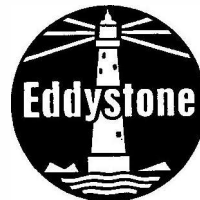

WE HAVE A  
COMPREHENSIVE  
STOCK OF  
EDDYSTONE RECEIVERS

NOTE: *We offer*

- HIRE PURCHASE TERMS
- PART EXCHANGE

*Come along and see us or  
ring the above number.*

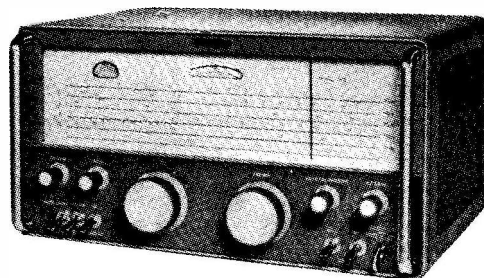

EDDYSTONE 940 RECEIVER Price £133.0.0

### FAMOUS ARMY SHORT-WAVE TRANSRECEIVER MK.III

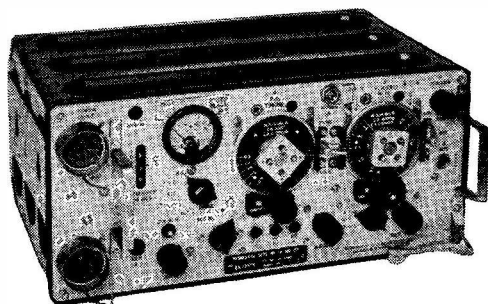

This set is made up of three separate units (1) a two valve amplifier using a 6V6 output valve; (2) (some only, not built in the very latest models) a V.H.F. transreceiver covering 229-241 Mc/s. using 4 valves; (3) the main shortwave transmitter/receiver covering, in two switched bands, just below 2 Mc/s.-4½ Mc/s., and 4½ Mc/s.-8 Mc/s. (approx. 160-37.5 metres) using 9 valves. For R.T., C.W. and M.C.W. The receiver is superheterodyne having 1 R.F. stage, frequency changer, 2 I.F. (465 Kc/s.) signal detector, A.V.C. and output stage. A B.F.O. included for C.W. or single side-band reception. T.X. output valve 807 other valves octal bases. Many extras, e.g. netting switch, quick flick dial settings, squelch, etc. Power requirements LT 12 volts, HT receiver 275 volts D.C., HT transmitter 500 volts D.C., size approx. 17½ x 7½ x 11 ins. Every set supplied in new or as new condition in carton with book including circuits, only £4 10s. 0d., or Grade 2 slightly used 50s., carriage both 15s.

A FULL KIT of brand new attachments for this set including all connectors, control box, headphones and mike, aerial tuning unit, co-axial lead, etc. at only 45s., carriage 5s. 12 VOLT D.C. power unit with all connectors to set and battery, 30s., carriage 5s. WE MAKE A MAINS 200/250 VOLT POWER UNIT in louvered metal case to plug direct into set power socket to run (1) receiver, 70s., post 5s.; (2) TX and RX, £6 10s. 0d., post 7s. 6d. A charge of 10s. to unpack and test the receiver of these sets is made only if requested.

### WALKIE-TALKIE MK III and CRYSTAL CALIBRATOR No. 9

This set is housed in a waterproof diecast aluminium case made by Murphy Radio for the Govt. having only reliability and quality in mind. Range 7.3-9 Mc/s. also on side of set is crystal calibrator No. 9 which gives pip on marks provided on the tuning dial. Set uses a total of 5 valves; power required L.T. 4 volts D.C., H.T. 100-175 volts D.C. Sets supplied in NEW or as new condition, boxed, only 50/- Carriage 10/-.

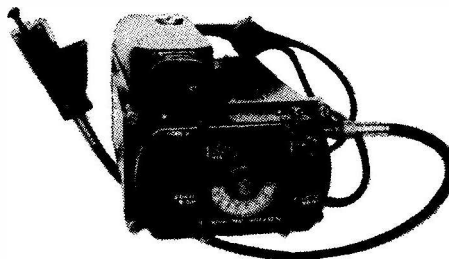

JOHN'S RADIO (Dept. F)  
OLD CO-OP, WHITEHALL ROAD, DRIGHLINGTON, BRADFORD Tel. DRIGHLINGTON 732

# Fast Mail Order for the Amateur Radio Enthusiast!

## AERIAL EQUIPMENT

**TWIN FEEDER.** 300 ohm twin ribbon feeder similar K25, 8d. per yard. 75 ohm twin feeder, 6d. per yard. Post on above feeders and cable, 2/- any length.

**COPPER WIRE,** 14G, H/D, 140ft., 30/-; 70ft., 16/- Post and packing 3/3. Other lengths pro rata.

**FEEDER SPREADERS.** 6" Ceramic type F.S., 10d. each. Postage 2/6 up to 12.

**CERAMIC CENTRE PIECE** for dipoles Type AT, 1/6 each. P. & P. 1/-.

**2 METRE BEAM, 5 ELEMENT W.S. YAGI.** Complete in box with 1" to 2 1/2" masthead bracket. Price 56/-, P. & P. 4/-

**SUPER AERAXIAL,** 70/80 ohm coax, 300 watt very low loss, 2/3 per yard. 50 ohm 300 watt, 2/6 per yard. P. & P. 2/6.

**TOUGH POLYTHENE LINE,** type MLI (100lb.), 2d. per yd. or 12/6 per 100 yds. Type ML2 (220 lb.), 4d. per yd. or 25/- per 100 yds., ML4 (400 lb.), 6d. per yd. Ideal for Guys, L.V. Supports, Halyards, etc. Postage 1/6 on all line.

## MIDLAND AGENTS FOR EDDYSTONE

Receivers & Components

Transmitters, Receivers and Sundry Equipment by

- KW ELECTRONICS
- GREEN E.C.E.
- T.W. ELECTRONICS
- CODAR RADIO
- C.S.E.

**NEW BOXED VALVES.** 3/6 each, 4 for 10/-, P. & P. 2/-.

Types 6N7GT, 6AB7, 6AC7, 6SK7, 6K7, 6SF7, 6SH7, 6F7, 956.

**ABSORPTION WAVEMETERS.** 3-00 to 35-00 Mc/s. in 3 Switched Bands. 3-5, 7, 14, 21 and 28 Mc/s. Ham Bands marked on scale. Complete with indicator bulb. A MUST for any Ham Shack. ONLY 25/- EACH. Post free.

**SHADED POLE MOTORS.** 240v., 50 c/s. Suitable for saws and blowers, 12/6 each, P. & P. 2/6.

**VARIABLE CONDENSERS.** All brass with ceramic end plates and ball race bearings. 50pF, 5/9; 100, 6/8; 160, 7/6; 240, 8/6. Extension for ganging. P. & P. 2/-.

**SEALED RELAYS,** 12v. 105Ω Coil. Type A. 4 Pole, C.O. 15/- Type B.2 Pole, C.O. + 2 Pole Norm. on, 12/6. P. & P. 1/6.



The Widest Range in the Midlands

★ HIRE PURCHASE  
★ PART EXCHANGE

CHAS. H. **YOUNG** LTD.

At your service G2AK, G3LAY, G3VVF

Please print your address. No. C.O.D. under £1.

'phone 021-236-1635

170-172 Corporation Street,

Birmingham 4

## SWANCO PRODUCTS

LIMITED

G3NAP AMATEUR RADIO SPECIALISTS G3PQQ

### NEW EQUIPMENT

	£ s. d.
Sommerkamp F-Series SSB Equipment	
FR-100B double conversion superheterodyne with crystal controlled first mixer, 80-10 metres	112 0 0
FL-200B SSB/AM/CW transmitter, 240 watts PEP. Complete with built-in power supply and antenna relay	130 0 0
FL-1000 Linear Amplifier, 960 watts PEP with built-in PSU and designed to match any SSB exciter capable of 30-100 watts	90 0 0
FT-100 SSB Transceiver. Still in production.	180 0 0
Sommerkamp Mobile TS-600-G Transceiver (10m.)	50 0 0
Tokai TC-99 28.5 mc/s. hand-sets	10 10 0
Swan Transceivers also now available.	
Swan 400 watt transceiver, 80-10 metres. Full coverage	250 0 0
Lafayette Equipment	
HAM-1 4-band Communications Receiver	16 16 0
HA-63A Communications Receiver	25 4 0
KT340 Communications Receiver in Semi-Kit Form	26 5 0
HA-500 Amateur band double superhet	44 2 0
HA-700 Receiver (with 2 mechanical filters)	37 16 0
HA350 10-80 metre SSB/AM/CW Amateur Receiver	78 15 0
Contactor Switchgear (Electronics)	
CSE 2A10 solid state transmitter	43 7 0
CSE 2AR solid state receiver	44 0 0
CSE Type II A.T.M.A. mobile/portable/fixed antenna	9 15 0
CSE microphone, Type MM2	2 17 11

Full range of KW equipment available.

### Partridge Electronics

	£ s. d.	Shure Microphones	£ s. d.
Joystick Std.	4 15 0	Shure 201 microphone	4 10 0
Joystick De Luxe	5 19 6	Shure 202 noise-cancelling microphone	5 0 0
Type 3 Tuner	2 15 0	Shure 444 microphone	10 12 0
Type 3A Tuner	3 12 6	Shure 401A microphone	5 10 0
Type 4 Tuner	4 4 0	Shure 275SK microphone	4 2 6
Type 4RF Tuner	6 6 0		

### SECOND-HAND EQUIPMENT

Many items in stock, including: LG-300, FL-200B, MR-44, SP600S, BC348, etc., your enquiries please.

### WANTED

Your modern receivers, transmitters, SSB gear, etc. Please send full details, stating price required. We will settle any existing hire purchase. Full H.P. facilities now available. One third deposit, 12, 18 or 24 months to pay. High trade-in allowance on used equipment. Details on request.

247 HUMBER AVENUE, COVENTRY

Telephone Coventry 22714 After 7.30 p.m.: G3NAP Tile Hill 64279 G3PQQ Keresley 3456

## WESAK RADIO

Telephone: CARDIFF 29972

NATIONAL NCX3 Transceiver. 20-40-80 Metres, 200 watts P.E.P. with A.C. p.s.u. Cash price	£120
NATIONAL H.R.O. with 8 coils and A.C. p.s.u., F.B. condition	£19 10s.
HAMMARLUND super pro. 100 Kc/s.-20 Mc/s.	£20
RI07. Very good condition	£11 10s.
EDDYSTONE S640. Good for spares only	£6

FOR THE BUILDER—R's—C's, Transformers, Valves, Transistors, Diodes, Meters (many types).

### Special Offer:

TZ40 ..	(p. & p. 2/-)	15/-
5B254/M ..	(p. & p. 2/-)	£1 5s.
6L6G... ..	(p. & p. 2/-)	7/6

AR88 Mains Transformers	
Two only ... ..	(p. & p. 7/6) £2 5s.
813 Heater Transformer	(p. & p. 7/6) £1 5s.

Valves for H.R.O. (6D6-6C6, etc.) (p. & p. 1/6) 5/6

Service Manuals:	
for H.R.O. (all models)	(p. & p. 1/-) £1 5s.
for AR88D	(p. & p. 1/-) £1 5s.

Any new equipment supplied. All enquiries welcomed

H.P. available £35 and over

54 DANIEL STREET, CATHAYS, CARDIFF, S. WALES



**COME RAIN-COME SHINE NOW IS ANTENNA-TIME**

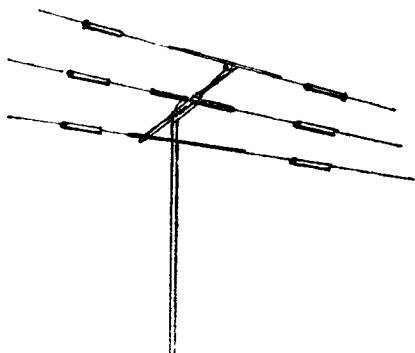

TA-33 Jr.

SOME OF OUR ANTENNAS

- VERTICALS :** RV-4. 10, 15, 20 and 40 metres.  
 V-4-6. 10, 15, 20 and 40 metres.  
 V-3 Jr. 10, 15 and 20 metres.  
 VTD Jr. 10, 15 and 20 metres.  
 TW-2X. El Toro. 20, 40 and 80 metres.  
 TA-31 Jr. 10, 15 and 20 metres. Also Horizontal.  
 MA-3. Mobile Whip. 10, 15 and 20 metres.

- HORIZONTALS :** TA-33 Jr. TA-32 Jr. 10, 15 and 20 metre beams.  
 MP-33. 10, 15 and 20 metre beam.  
 A-203-C. 20 metre monoband beam.  
 A-315. 15 metre monoband beam.  
 A-310. 10 metre monoband beam.  
 TA-33, TA-32 and TA-36. 10, 15 and 20 metre kW rating beams.  
 TD-3 Jr. 10, 15 and 20 metres. Trapped dipole.

Short Wave Listeners' Antennas : SWL-7 Broadcast Short Wave Bands.  
 RD-5 Ham Bands. 10, 15, 20, 40 and 80 metres.

**NEW : Available May/June. The Mosley 'ELAN.' 10 and 15 Metre, 3 Element Beam. Designed and manufactured in England. Full details later. Price £23.**

**SELECTED PRICES**

TA-32 Jr. ...	£19 5 0
TA-31 Jr. ...	£11 0 0
MP-33 ...	£32 17 0
A-315 ...	£19 16 0
A-203-C ...	£46 5 0

Carriage and Insurance extra.

Send for complete Catalogue, containing full details of Antennas and other technical information. 25 pages 1/-.

Telephone: Costessey 2861, orders only

**Mosley Electronics Ltd.** 40, Valley Road, New Costessey, Norwich, Norfolk Nor. 26K

**N. W. ELECTRICS**

52 GT. ANCOATS STREET  
 MANCHESTER 4

CEN  
 6276

THE NORTH'S LEADING STOCKISTS OF

**THIS MONTH'S SPECIAL OFFERS**

**Advance Signal Generator Type 71.** Mains input, 10 to 320 Mc/s. in 6 Bands. Sine and square wave modulation. 1uV. to .1V. Calibrated Attenuator. As new and tested, £10 plus 17/6 carriage and packing.

**CT54 Valve Volt-Meter.** 4" rectangular meter, 2-4-480v. AC and DC in 6 ranges. 1K-10M ohm, 5 ranges RF probe and 2,400v. multiplier. Fitted with battery box, requires 2 x 1-4v., 75v. and 15v., £10/15/-, 10/- p. and p. AC power supply components available shortly. Circuits and information supplied.

Coax Cables, Aerial Wires and other items recently advertised available, with the exception of Command Receivers.

**G3MAX, G3SMI, G8SB**

**EDDYSTONE RECEIVERS & COMPONENTS**

**T.W. ELECTRONICS  
 RECEIVERS, TRANSMITTERS,  
 CONVERTERS**

**SOMMERKAMP FL-200-B TX  
 HALSON MOBILE AERIALS**

**DENCO COMPONENTS**

**'Q' MAX CHASSIS CUTTERS**

We have tremendous stock of small components for Valve and Transistor Circuits, Meters, Test Equipment, G.D.O's. Field strength Meters.

Specialists in repair, alignment of all types of communication receivers.

TECHNICAL  
PUBLICATIONS  
LATEST ISSUES

	Post Free
AMATEUR RADIO ANTENNA HANDBOOK. 157 pages (by H. D. Hooton, W6YTH) .....	24s. 0d.
ANTENNA ROUND-UP (by CQ) .....	25s. 0d.
ANTENNA ROUND-UP (Vol. 2) .....	38s. 0d.
ANTENNA HANDBOOK (A.R.R.L., 10th Edition) .....	19s. 6d.
BASIC MATHEMATICS FOR RADIO AND ELECTRONICS .....	18s. 3d.
BEAM ANTENNA HANDBOOK, New Edition .....	28s. 0d.
BETTER SHORT WAVE RECEPTION .....	24s. 0d.
CHART OF INTERNATIONAL FREQUENCY ALLOCATIONS—GENEVA (Official, 10 Kc to 40 Gc.). New Edition. 24in. x 16in. wide folding pages .....	31s. 6d.
COMMUNICATION RECEIVERS .....	3s. 5d.
CQ ANTHOLOGY 45-52 .....	16s. 9d.
CQ ANTHOLOGY (1952-1959) .....	25s. 0d.
COURSE IN RADIO FUNDAMENTALS (A.R.R.L.) .....	10s. 6d.
ELECTRONIC CIRCUITS HANDBOOK .....	24s. 0d.
FOUNDATIONS OF WIRELESS .....	22s. 3d.
FUNDAMENTALS OF SINGLE SIDEBAND (Collins) .....	49s. 6d.
GETTING STARTED WITH TRANSISTORS (GERNSBACK) .....	28s. 6d.
GUIDE TO AMATEUR RADIO .....	5s. 9d.
GUIDE TO BROADCASTING STATIONS .....	6s. 9d.
HAM ANTENNA CONSTRUCTION PROJECTS. 157 pages (Sams) .....	24s. 0d.
HAMS INTERPRETER .....	8s. 6d.
HANDBOOK OF HAM RADIO CIRCUITS (by W9CGA) .....	24s. 0d.
HINTS AND KINKS Vol. 6 .....	11s. 0d.
HOW TO BECOME A RADIO AMATEUR (A.R.R.L.) .....	10s. 0d.
HOW TO IMPROVE SHORT WAVE RECEPTION .....	20s. 0d.
"HOW TO LISTEN TO THE WORLD" .....	27s. 3d.
LEARNING MORSE .....	2s. 3d.
LEARNING THE RADIO TELEGRAPH CODE (A.R.R.L.) .....	4s. 6d.
MOBILE HANDBOOK (Published by CQ) .....	24s. 0d.
MOBILE MANUAL (Published by A.R.R.L.) .....	24s. 6d.
MODEL RADIO CONTROL (E. L. Safford) .....	25s. 0d.
NEW RTTY HANDBOOK .....	32s. 0d.
NEW SIDEBAND HANDBOOK (by CQ) .....	25s. 6d.
NOVICE HANDBOOK, Tx and Rx, 150 pages .....	23s. 6d.
OPERATING AN AMATEUR RADIO STATION (A.R.R.L.) .....	2s. 0d.
PORTABLE TRANSISTOR RECEIVER .....	3s. 0d.
QUAD ANTENNA .....	23s. 0d.
RADIO AMATEUR EXAMINATION MANUAL .....	5s. 9d.
RADIO AMATEUR HANDBOOK (A.R.R.L.), 1967 .....	44s. 0d. Paper Edition 54s. 0d. Buckram Edition
RADIO AMATEUR OPERATOR'S HANDBOOK (Data Publications) .....	5s. 6d.
RADIO AMATEUR CALL BOOK (U.K. only, 1967) .....	6s. 7d.
RADIO CONTROL FOR MODELS (F. C. Judd) .....	16s. 0d.
RADIO DATA REFERENCE BOOK .....	14s. 0d.
RADIO HANDBOOK (Wm. I. Orr) (17th Edition) .....	86s. 0d.
RADIO VALVE DATA (Hiffe). Eighth Edition .....	10s. 7d.
SSB EQUIPMENT .....	3s. 3s.
S9 SIGNALS .....	8s. 6d.
SHORT WAVE LISTENING .....	13s. 2d.
SHORT WAVE RECEIVERS FOR THE BEGINNER (Data Pubs.) .....	6s. 6d.
SHORT WAVE RADIO AND THE IONOSPHERE (Hiffe) .....	11s. 9d.
SINGLE SIDEBAND FOR THE RADIO AMATEUR (A.R.R.L.) (4th Edition) .....	22s. 6d.
SURPLUS SCHEMATICS (Published by CQ) .....	21s. 0d.
SURPLUS CONVERSION HANDBOOK (including "Command Sets") .....	24s. 0d.
TECHNICAL TOPICS FOR THE RADIO AMATEUR .....	10s. 8d.
TELEVISION EXPLAINED (Hiffe) .....	13s. 6d.
TRANSISTORS THEORY AND PRACTICE (R. P. Turner) .....	23s. 0d.
TRANSISTOR RADIO HANDBOOK (Editors and Engineers) .....	45s. 0d.
UNDERSTANDING AMATEUR RADIO .....	19s. 6d.
VHF HANDBOOK (Orr W6SAD) .....	24s. 0d.
VHF MANUAL by A.R.R.L. .....	21s. 6d.
VHF FOR THE RADIO AMATEUR (CQ) .....	28s. 0d.
WORLD MEDIUM WAVE GUIDE .....	16s. 9d.
WORLD RADIO AND TV HANDBOOK, 1967 .....	32s. 6d.

Available from **SHORT WAVE MAGAZINE**  
 Publications Dept., 55 Victoria St., London S.W.1 · Abbey 5341  
 (Nearest Tube Station : St. James's Park)

**DRAKE**  
**2-C**  
**RECEIVER**  
£99

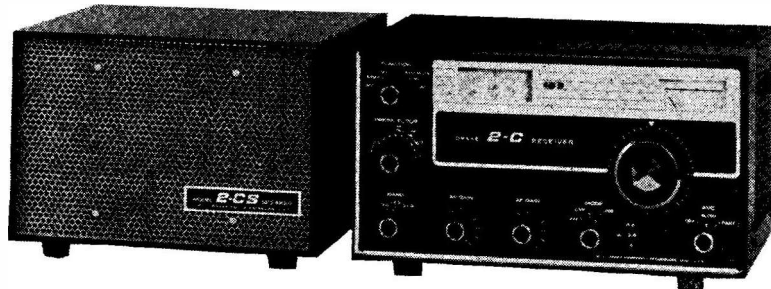

**FEATURES**

- \* Covers ham bands 80, 40, 20, 15 meters completely and 28.5 to 29.0 MHz of 10 meters with crystals furnished.
- \* Or tunes any 500 kHz range between 3.0 and 30 MHz with an accessory crystal.
- \* Three Bandwidths of selectivity (equivalent to 3 filters) are furnished: .4 kHz, 2.4 kHz and 4.8 kHz.
- \* Solid State Audio with 1.8 watts output.
- \* Solid State AVC with fast attack and slow release for SSB or fast release for high break-in CW. Also AVC may be switched off.
- \* Receives SSB, AM, CW, and RTTY with full RF gain, complete AVC action and accurate S-meter indication.
- \* Product Detector for SSB/CW—diode detector for AM.
- \* Excellent overload and cross modulation characteristics; insensitive to operation of nearby transmitters.

for details write or phone:-

**Philadelphian Electronics Ltd**

Tel:- 01-624  
6638

188-190 Broadhurst Gardens, London, N.W.6.

**FIXED OR MOBILE** . . . the **TW COMMUNICATOR Mk. II**  
**MAKES THE MOST OF YOUR POWER & LOCATION**



**EASY TO INSTALL**

**SIMPLE TO OPERATE**

**RECEIVER.** Double conversion. All solid state. Complete with noise limiter B.F.O. and low noise V.H.F. converter. Transmitter 15 watts input.

High level plate and screen modulation. Built-in solid state P.S.U. The Communicator is now available for — VE earth Systems.

**WE TAKE A PRIDE IN OUR EQUIPMENT · YOU WILL BE PROUD TO OWN IT**



SEND FOR DETAILS OF OUR COMPLETE RANGE OF VHF EQUIPMENT

**T.W. ELECTRONICS**

120 Newmarket Road, Bury St. Edmunds, Suffolk. Telephone: Bury St. Edmunds 3931

## Electroniques are proud to announce their appointment as exclusive UK agents for the Hallicrafters company

This advanced range of receivers, transmitters and transceivers bear the famous Hallicrafters hallmark "QUALITY THROUGH CRAFTSMANSHIP". All equipment is currently available ex-stock from our Harlow

warehouse. Working demonstrations of the SR 2000 can be arranged on Saturday mornings by appointment. Credit sales and hire purchase quickly available. Where equipment is designed for 110V operation a

free auto transformer is provided.

The Hallicrafters line will be fully described in a catalogue available later this year. In the meantime catalogue sheets are available on all products shown.

### First availability in Europe! SR 2000 Hurricane transceiver idles along at UK amateur power limit! Command the frequency!

- 2000 watts PEP input—high/low switch
- Two 8122 tubes in final
- 80 to 10 metres. Full coverage crystals for 10M band
- Crystals for commercial bands available
- Built in VOX plus BK CW and PTT
- Built in CW sidetone
- 50 dB carrier suppression
- Audio 500-2600 c/s at 6dB
- Switched upper/lower sidebands
- Receiver 1 $\mu$ V for 20 dB S/N ratio
- Dial calibration 1 Kc/s linear
- IF noise blanker
- Built in 100 Kc/s calibrator
- Receiver offset control
- Exclusive amplified ALC
- S Meter and grid current meters in transceiver
- Plate volts and current meters in power unit
- Adjustable PI-net output

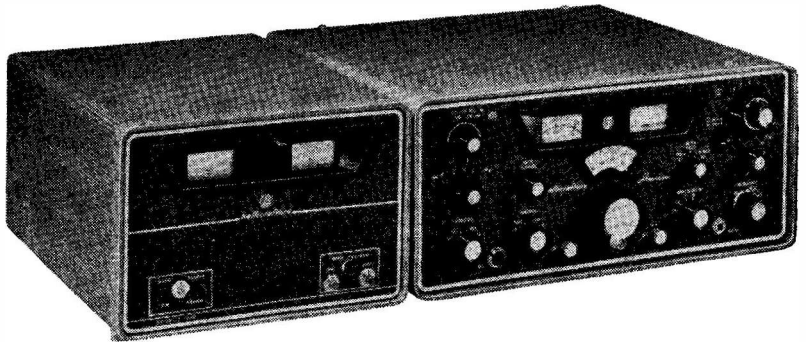

### HT46 SSB transmitter has unique single-conversion signal—conversion signal path all bands! Quartz filter for SSB and CW! Transceives with SX146—or unlock for full coverage VFO!

- 175 watts input SSB
- 150 watts input CW
- PTT provided; VOX available
- 500 Kc/s bands 80-10 metres—commercial frequencies at option
- 28.5 to 29.0 Mc/s XTAL supplied — other 10M XTALS at user option
- 50dB carrier suppression
- 52 ohm PI-net output
- Meters MA/RF output
- Self contained solid state power unit

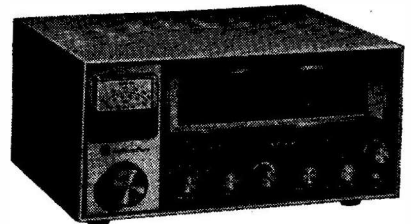

electroniques the *hallicrafters* agents

**SX146 SSB Receiver has single conversion signal path all bands! Premixed oscillator chain! Transceives with HT46—or unlock for split frequency working!**

80 to 10 metres—commercial frequencies at option  28.5 to 29.0 Mc/s crystal supplied—other 10M crystals at user option  Three selectivity positions—

0.5, 2.1, 5.0 Kc/s—2.1 Kc/s standard—other filters at user option  S-Meter provided  Built in power unit.

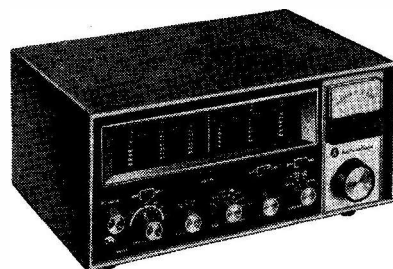

**SX130 General Coverage Receiver covers medium wave and shortwave to 31.5 M/cs! AM/CW/SSB reception! Calibrated bandspread!**

Continuous coverage 535 to 31.5 Mc/s  Hambands 160M to 10M  Electrical Bandspread 80M to 10M bands  Crystal Filter built in  S-meter provided

CW/AM/SSB—USB/LSB selectable  Built in power unit  Uses external speaker

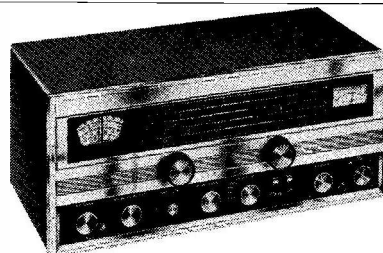

**SX122 Receiver has double conversion! Broadcast plus three shortwave bands! Selectable sidebands and bandspread hambands!**

Coverage 538 Kc/s to 34 Mc/s  Electrical bandspread fully calibrated  Antenna trimmer  Nine valves plus semi-

conductors  S-Meter  Power unit built in  Dual conversion on all bands



**HA1 Electronic Keyer (not illustrated) uses digital techniques! Self completing dits and dahs clean up your sending! Constant ratio circuits!**

Employs digital techniques  Suits SR2000, HT46 and all transmitters  Constant-ratio self-completing dits

and dahs  Transformer operated  Vacuum sealed mercury wetted keying relay  Speed adjustable 10 to 65 wpm

**Transceivers**

SR2000 Hurricane £495  
P2000 AC Power  
Meter and Speaker Unit £195

**Transmitter/Receiver Combinations**

HT46 SSB Transmitter £175  
SX146 SSB Receiver £125

**Receivers**

SX122 General Coverage £135  
SX130 General Coverage £79

**Accessories**

HA16 VOX Adapter for HT46 Transmitter £19.10.0  
HA7 100 Kc/s calibrator for SX122 Receiver £s.15.0  
HA19 100 Kc/s calibrator for SX146 receiver £9.15.0  
HA1 Electronic Keyer for any transmitter £39

Electroniques (Proprietors STC Ltd.),  
Edinburgh Way, Harlow, Essex. Telephone: Harlow 26777

*hallicrafters* equipment by

**GE**  
electroniques

# Make your own SCOOTER ALARM

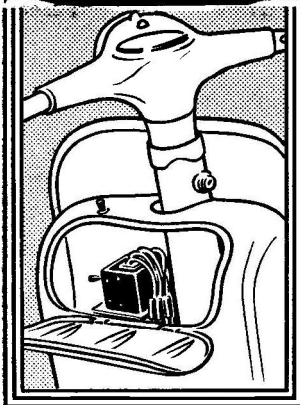

Simple to construct from full instructions in **PRACTICAL ELECTRONICS**, this instant alarm will safeguard your scooter or accessories against theft.

**ALSO** constructional details for an *Electronic Bass Guitar* and a *Light Operated Stopwatch* (for start-to-finish timing at sports events).

## PRACTICAL ELECTRONICS

MAY ISSUE OUT NOW 2.6

### G3ZY J. & A. TWEEDY (Electronic Supplies) Ltd.

APPOINTED DEALER AND STOCKIST

EDDYSTONE, ELECTRONIQUES, CODAR, EAGLE, SOMMERKAMP, KW ELECTRONICS

NEW EQUIPMENT		£	s.	£	s.
Eddystone EC10	...	48	0	Sommerkamp FL 200B	130 0
Eddystone 940	...	133	0	Sommerkamp FR 100B	112 0
Eddystone EA12	...	185	0	Sommerkamp FL 1000	90 0
Edometer Dip Osc.	...	19	10	Sommerkamp FT 100	180 0
Ham-1 Receiver	...	16	16	Lafayette HA63A Rx	25 4
Starr SR550 Rx	...	59	17	Starr SR165 Rx	38 10
Codar ATS Tx	...	16	10	Codar CR70A Rx	19 10
Codar AT5 AC p.s.u.	...	8	0	Codar PR30X Pre-selector	7 4
Codar AT5 DC p.s.u.	...	11	5	Codar PR30 Preselector	5 10
Codar RQ10X "Q" Mult	...	8	8	Codar T28 Preselector	15 10
Codar RQ10 "Q" Mult	...	6	15	Codar CC40 Control Unit	6 10
KW EZ Match	...	12	10	KW Baluns	1 15
KW Low Pass Filters	...	4	4	Electroniques GC166 and QP166 Mk. VI	
Green Latest 2M20	...	45	0	Coil pax	12 12

**VALVES :** 6J56A 35/-, 6J16A 25/-, 6146B 52/6 + 1/- P. and P.  
**TRANSISTORS.** At 2/- each : AC126, AC127, AC128, OC75.  
2/3 each : OC81, OC81D, OC82, OC82D. 2/6 each : OC44, OC45.  
3/- each : OC46, OC70, OC71, OC72, OC76, OC78, OC78D, OC84,  
AF118, AF119, OC169, OC170, OC172. 3/3 each : AF117. 3/6 each :  
AF115, AF116, AF125, AF127, AC107. 7/6 each : OC200. 7/- each :  
OC23, OC25, OC26, OC28. 11/- each : AD140. 11/6 each : OC35,  
OC38.

Several used transmitters and receivers.

H.P. TERMS AVAILABLE TRADE-INS ACCEPTED

64 LORDSMILL STREET, CHESTERFIELD, DERBYSHIRE  
Tel: Chesterfield 4982 or Holmewood 506 (Evenings)

## MORE TITLES AVAILABLE FROM STOCK

BEGINNER'S GUIDE TO RADIO (Newnes)	9/-	
BEGINNER'S GUIDE TO COLOUR TELEVISION (Newnes)	15/8	
BEGINNER'S GUIDE TO ELECTRONICS	15/6	
DICTIONARY OF ELECTRONICS (Penguin)	8/6	
ELECTRICAL HOBBIES (Collins)	5/6	
ELEMENTS OF RADIO ENGINEERING (Cleaver-Hume)	15/10	
Q. & A. ON (Newnes)	AUDIO	10/-
	ELECTRONICS	10/-
	TRANSISTORS	10/-
SHORT WAVE LISTENING (by J. Vastenhoud)	13/2	
INTRODUCTION TO VALVES (Iliffe's)	9/4	
RADIO ASTRONOMY FOR AMATEURS. 220 pages (by Frank Hyde)	31/-	
REMOTE CONTROL BY RADIO (Philips)	10/9	
RADIO & ELECTRONIC HOBBIES (by F. C. Judd, G2BCX)	22/-	
SHOP & SHACK SHORTCUTS (by W6TNS)	32/-	
SHORT WAVE AMATEUR RADIO (by PA0HH, Philips Technical Library)	22/-	

All prices inclusive of postage and packing

**SHORT WAVE MAGAZINE**  
55 VICTORIA STREET : LONDON, S.W.1  
PUBLICATIONS DEPARTMENT

**INDEX TO  
ADVERTISERS**

	PAGE
Amateur Electronics ...	186
Ara Press ... ..	188
Brensal Electronics, Ltd.	186
Britec, Ltd. ... ..	192
Charles H. Young ... ..	134
Contactor Switchgear (Electronics) Ltd. ...	187
Daystrom ... .. cover iv,	186
Derwent Radio ... ..	186
Diplomatic Wireless Service ... ..	132
Eddystone Radio ... .. cover ii	
Electroniques ... 129, 138,	139
Eley Electronics ... ..	192
Finnigan Speciality Paints	186
George Francis ... ..	185
G3HSC (Morse Records)	192
G.W.M. Radio ... ..	190
G. Hall & Sons, Ltd. ...	192
Hamgear Electronics ...	188
Henry's Radio ... ..	188
Home Radio, Ltd. ... ..	133
A. Imhof, Ltd. ... ..	191
John's Radio ... ..	133
K.W. Electronics <i>front cover, cover iii</i>	
Jack Tweedy ... ..	140
J. B. Lowe ... ..	131
JXK Converters ... ..	130
Marconi Instruments, Ltd.	183
Mosley Electronics ...	135
N.W. Electrics ... ..	135
Partridge Electronics, Ltd.	142
Peter Seymour, Ltd. <i>cover iii, 130</i>	
Philadelphian Electronics, Ltd. ... ..	137
Practical Electronics ...	140
R.T. & I. Electronics, Ltd.	191
Small Advertisements ...	184-192
Spacemark, Ltd. ... ..	192
Smith & Co., Ltd. ... ..	183
Stephens-James, Ltd. ...	190
S.S.B. Products ... ..	189
Swanco Products, Ltd. ...	134
S.W.M. Publications 136, 140, 184,	192
Taurus Electrical Services	185
T.W. Electronics ... ..	137
Wesak Radio ... ..	134
Yukan ... ..	188

# SHORT WAVE MAGAZINE

(GB3SWM)

Vol. XXV

MAY, 1967

No. 283

## CONTENTS

	Page
Editorial ... ..	143
High Voltage PSU for Sideband Transmitter, <i>by R. F. C. Bennett, G3SIH</i>	144
R.220 Front End for Four Metres, <i>by L. Case</i> ... ..	147
Valve Relay, Key Controlled ... ..	149
Communication and DX News, <i>by E. P. Essery, G3KFE</i> ... ..	150
VHF Bands, <i>by A. J. Devon</i> ... ..	158
Mobile Aerial Design for Top Band ... ..	160
Obituary—G. R. Scott-Farnie, G5FI ... ..	164
“SWL”— <i>Listener Feature</i> ... ..	166
HPX Rules ... ..	170
Mobile Rally Programme ... ..	172
The Month with The Clubs— <i>From Reports</i> ... ..	174
Specially on The Air ... ..	180
The Other Man's Station—9HIR ... ..	181
New QTH's ... ..	182

**Managing Editor:** AUSTIN FORSYTH, O.B.E. (G6FO/G3SWM)

*Advertising:* Maria Greenwood

*Published at 55 Victoria Street, London, S.W.1, on the last Friday of the month, dated the month following. (Telephone: ABBey 5341/2)*

*Annual Subscription: Home and Overseas 42s. (\$6.00 U.S.) post paid*

**Editorial Address:** Short Wave Magazine, BUCKINGHAM, England

### AUTHORS' MSS

*Articles submitted for Editorial consideration must be typed double-spaced with wide margins on one side only of quarto or foolscap sheets, with diagrams shown separately. Photographs should be clearly identified on the back. Payment is made for all material used, and it is a condition of acceptance that full copyright passes to the Short Wave Magazine, Ltd., on publication.*

© Short Wave Magazine Ltd.

# JOYSTICK VFA

## turns PRO!

### History repeats itself!

Throughout the development of radio communication the keen private experimenter has contributed largely to the advance of our science. The amateurs of the thirties pioneered reliable shortwave transmission and reception. Basic theories and their practical application are to this day latched in the fertile minds of ingenious men who are the leading amateurs of our time.

The Joystick Aerial System can now be regarded as the perfect example of a purely amateur development "turning professional." Thousands of Joystick variable frequency aerial systems have been sold. The enormous number of enthusiastic testimonials that have accumulated at the Joystick factory are now in themselves calling for a separate filing room! The continuing success of the VFA has not only spread right round the world but has finally penetrated the barrier of professional and official circles. Professional bodies in the U.S.A., Europe, Africa and the Far East have ordered VFA systems for operational use and for experimental work. Security forbids the whispering of names but clearance has been given to mention the Nigerian Police and an Australian fire control organisation.

In the Scottish fishing boats which have installed the system communication with other ships and shore stations has become considerably more reliable over difficult paths.

This VFA system is a remarkable invention and its unique quality of high performance at any selected frequency from 1 M/c. to 30 M/cs.—particular from difficult locations—has radically changed the attitude of both the licensed amateur and the shortwave listener towards their aerial problems.

Each Joystick VFA system is complete with a Joystick matching unit suitable for each type of operation.

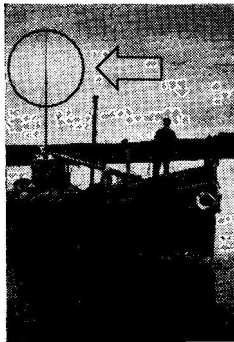

### Scottish Fishing Boats. Aerial Problems solved!

The Joystick aerial was successfully subjected to the most rigorous tests under appalling weather conditions aboard the MFV *Crystal Sea* OB104 and the MFV *Margaret Ann* OB79 out of Mallaig. Previously the old-fashioned wires had to be lowered every time the ships' derricks were used. Communication with shore stations and other ships was consistently good.

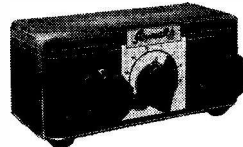

**Joystick Type 2A** — General medium wave coverage extending over short wave spectrum.

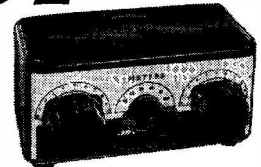

**Joystick Type 3A** — General short wave coverage for SWL. Bandswitched for amateur bands.

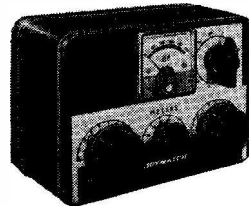

**Joystick Type 4RF** — For transmission and reception on 160-10 metres. Includes RF meter for peak efficiency.

**Joystick Type 4** — (Similar to Type 3A) For transmission and reception. Bandswitched on 160-10 metres.

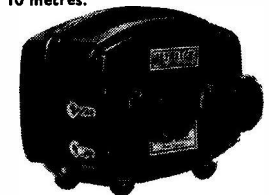

**Joystick Type 3** — General shortwave coverage SWL (Junior model).

You cannot afford to ignore the potential of the Joystick VFA. The system is simple to use—the Joystick VFA will clip to a chimney, tree or mast, can be laid upon a pelmet, stood in the corner of a room, will even give a good account of itself in a basement. Mobile Joystick systems are available and a new marine model has been introduced for the nautical types! You are strongly recommended to contact the Joystick factory immediately (or one of our agents) for a brochure with full details.

#### U.K. AGENTS:

G. W. Smith & Co. (Radio) Ltd., 3 Lisle Street, London, W.C.2.  
Stephens-James Ltd., 70 Priory Road, Liverpool, 4.

Chas. H. Young, 170/172 Corporation Street, Birmingham, 4.  
R.S.C. (Manchester) Ltd., 326 Argyle Street, Glasgow, C.1.

(and all branches)

SWANCO PRODUCTS LTD., 247 Humber Ave., Coventry.

LASKY'S RADIO (all branches), G3HSC, 45 Green Lane, Purley, Surrey.

(Demonstrations by appointment)—or ask your local dealer.  
World Wide Overseas Agencies.

#### Overseas:

France: Vareduc-Cominex, 2 Rue Joseph-Riviere, Paris, Courbevoix, France.

Scandinavia: Permo, Nygaardsgaten 42, Fredrikstad, Norway.

West Germany: Ing. Hannes Bauer, 86, Bamberg, Hornthalstrasse, 8  
Stotz & Goessl, 8 Munchen 15, Bayerstrasse 3.

and World Wide Agencies.

U.K. Pat. No. 1,045,481

U.S. Pat. No. 3,274,600

S. Africa Pat. No. 63/4389

and World Patents pending.

Post this coupon in the morning—without fail!

**PARTRIDGE ELECTRONICS LTD.**

Caister House, Prospect Road, Broadstairs, Kent.

NAME ..... Call Sign .....

ADDRESS .....

SWC



*The*  
**SHORT-WAVE**  
*Magazine*

E D I T O R I A L

**Law** *The proposed Wireless Telegraphy Bill—to revise and bring up-to-date the Act of 1949, under which we are at present governed—passed its Second Reading on April 18, and will be taken in Committee in due course. It is an extremely complicated measure, both as regards the ramifications of the subject it has to cover and in its drafting.*

*Certain ambiguities in the wording—or the meaning to be ascribed to the form of words used in the Bill—have already come to light and were raised in the House on April 18, by Mr. I. H. Gilmour and Mr. G. D. Wallace, both as it happens Members for Norfolk constituencies, though on opposite sides. Mr. Gilmour drew attention to the wide powers the Bill gave the GPO over radio amateurs and their licensing, and Mr. Wallace said that certain clauses in Part II might involve amateurs in difficulties over home-constructed equipment.*

*In his replies, the PMG implied that there is no intention, under the Bill as drafted, to make things in any way more difficult for radio amateurs, or to interfere with their activities in the technical sense. Indeed, Mr. Short is on record as saying “I want to do everything I can to help them,” and went on to remark that “Anything that was licensed would by definition be excluded”—meaning from the regulatory powers sought for by the Bill.*

*Of course, these are only the preliminary skirmishes, to establish lines of argument and discussion, and it is in Committee that the details are thrashed out. (At the moment of writing, it had not been announced when the Committee Stage would be taken.)*

*While all this is good enough as far as it goes, the position does need careful watching. The amateur interest only comes within a small part of the Bill, which covers a very wide range. Also, we should not lose sight of the fact that the GPO always has had pretty wide powers over the licensing and activities of radio amateurs, and that these powers have been used reasonably and with moderation—indeed, it can fairly be said that, within the regulations, the Post Office has always tried to be as co-operative as possible where Amateur Radio is concerned.*

*What is certain is that there is no intention, under the new Bill, to legislate punitively against radio amateurs, or even to make things more difficult for us. What we have to watch is that clauses about “interference” or “unsuitable apparatus,” and such, cannot be interpreted as creating a whole lot of new rules and disabilities for licenced radio amateurs.*

*The Member for Howden, Mr. P. E. Bryan, is the Shadow PMG and the responsible speaker for the Opposition on all these matters, and it is he who should be well briefed for the Committee Stage. Of course, if we can also have constructive comment and informed opinion from other quarters of the House, so much the better.*

*Austin Forth,  
G6FO.*

## HIGH VOLTAGE PSU FOR SIDEBAND TRANSMITTER

GIVING HV/LV AND BIAS  
SUPPLIES

R. F. C. BENNETT (G3SIH)

WITH the advent of Single Sideband, transmitting equipment has become smaller, in physical size, for the same effective power input as an AM transmitter. The power supply, however, appears to have remained the same weighty piece of gear and in some instances may even be heavier than necessary. The PSU described here will supply all the power needed for an amateur-band SSB transmitter, from a cabinet only 15½ins. wide, 7ins. deep and 6ins. high.

### Circuit

Two transformers are used, one for the high voltage line and the other the 300-volt HT supply and bias voltages. Since the writer's transmitter runs two TT21 valves in the final amplifier the HT required was 900 volts. Consequently, if two 6146 valves are used, then the secondary voltage of transformer T1 will require modification to obtain a HV/DC line of 750 volts. Two stabilised output voltages are provided, one at 300 volts for the TT21 screens and one at 150 volts for the VFO and crystal oscillators. (If 6146 valves are used in the transmitter PA then the 300-volt stabilised line can be omitted.) The secondary of T1 is switched (S3) to enable the DC line voltage to be reduced to 450 volts and, of course, the voltage dropping resistors (R11, R12) in the anodes of stabilisers V1 and V2 are switched at the same time.

The high voltage line is smoothed with four electrolytic capacitors C4-C7 wired in series. These condensers are rated at 350 volts DC working and are 60-250  $\mu$ F each. They are wired so that each capacitor has a total capacity of 310 (250 + 60) microfarads. The total effective smoothing capacity across the 900 volt HT line is therefore 77.5  $\mu$ F with a DC working voltage of 1400v. Voltage sharing across each capacitor is accomplished by means of the 47K resistors R7-R10. This large value of smoothing capacity is necessary because the current drain on the line is fluctuating at syllabic rate and the capacitors tend to hold the HT line up under these somewhat violent conditions.

The rectifier MR1 is a full-wave silicon bridge using four diodes per arm, complete with voltage-sharing resistors, R13-R28. The diodes used by the writer have a p.i.v. rating which is greatly in excess of what is generally available on the market for home constructors. However, the diodes quoted in the Table of Values are equally suitable. It should be noted that if the Mullard diode type BY100 is used then the voltage sharing resistors R13 to R28

will probably require modification in accordance with the manufacturer's recommendations.

The surge current drawn by the smoothing capacitors C4, C5, C6, C7 could be quite large, and although the reactance of the T1 helps to limit this, it is better to be wise before, rather than after, the event. Therefore, a 100-ohm resistor R1 is incorporated in the primary of T1 to limit any surge currents which could damage the diodes comprising MR1 when the power supply is switched on.

The 300-volt H1 line again uses silicon diodes giving full-wave rectification. The voltage-sharing resistors have been omitted from the diodes since there are only two diodes in series. The smoothing circuit is the usual LC filter arrangement.

The bias supply is derived by rectifying the voltage appearing across one half of the secondary winding of T2. Half-wave rectification is used and the rectifier MR3 feeds a voltage stabiliser valve V3 which gives a negative supply of 100 volts (105 volts to be exact). The resistors R4, R5, R6 and VR1 are really part of the transmitter control circuit and were only incorporated in the power supply cabinet for convenience. Capacitor C3 smoothes the bias line and the two sections of this condenser are wired in parallel to obtain a total effective capacity of 48  $\mu$ F.

The entire power supply is controlled by the relay RL1. When this relay is energised by closing S2 the surge limiting resistor R1 is shorted out and the 900-volt and 300-volt HT lines are connected to the output socket. If failure of the bias supply should occur then RL1 is automatically de-energised, thereby removing *all* high voltage supplies to the transmitter. This safety precaution was designed into the power supply because the failure of bias when operating an SSB transmitter can be very serious. The transmitter PA valves would be doomed to failure and the receiver would be subject to severe RF overloading. In other words, prevention is better than cure!

### Mechanical Details

The entire power supply is constructed in a TU5B tuning unit case measuring 15½ins. wide, 7ins. deep and 6ins. high. The layout of the main components can be seen in the photograph on p.146. MR1 is built on a printed circuit board, such as *Veroboard*, 7ins. long and 2ins. wide. This board is held to the front panel by two ceramic stand-off insulators. MR2 and MR3 are mounted on a piece of *Veroboard* 2ins. square and bolted to the chassis by means of 6 BA eyebolts. Condensers C4, C5 and C6 must be insulated from chassis by wrapping p.t.f.e. or p.v.c. tape round the bottom of the cans before bolting them in place by means of their clips. The bases of V1, V2 and V3, and relay RL1 are held to the chassis by long 4 BA screws. R1, R11 and R12 are mounted on ceramic stand-off insulators.

The front panel carries the mains switch S1, relay switch S2, high voltage selector switch S3 and bias potentiometer R1—see photograph. The rear panel carries the mains input socket, power output

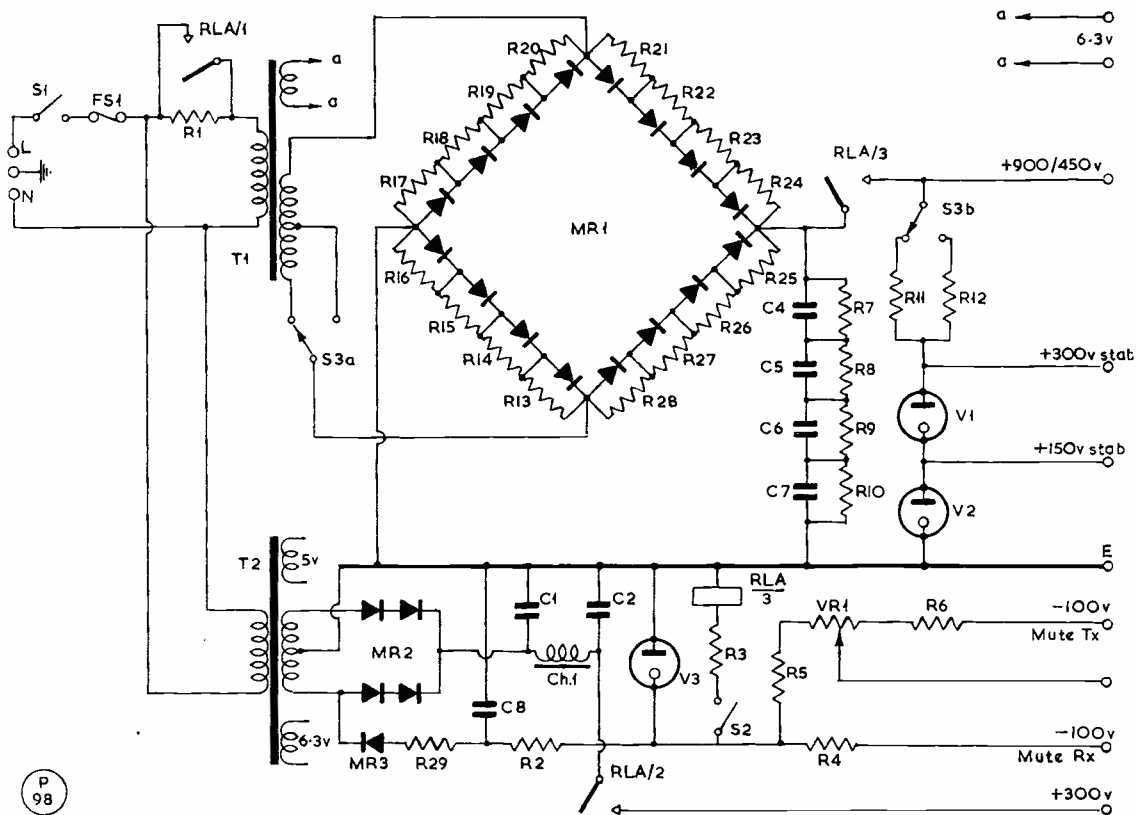

P 98

**Circuit of the High-Voltage PSU described by G3SIH.**

Note that in this circuit C3 should appear between the junction of S2-R5/R4 and the earth line.

octal socket, mains fuse and the high voltage (900-volt) output coaxial socket.

All wiring is of the 250 volt AC p.v.c. covered type with the exception of the circuit from the secondary of T1 to the output socket, which is wired in polythene covered wire. (This wire is similar to the type used in TV sets for the EHT circuit.)

**Operation**

Apply mains voltage to the input socket and close S1, wait a few seconds and close S2. Power should now be on the transmitter. The 900-volt HT line can be reduced to 450 volts by means of S3 if desired. Failure of the bias supply will automatically remove all high voltage from the transmitter, as already mentioned.

When changing from high voltage to low voltage on S3 ensure that the power supply is switched off at S1 and S2. This will prevent arcing of S3 switch contacts.

**Caution**

The use of silicon diodes in a power supply such as this one means that the HV is there the instant

**Table of Values**

**Circuit of the Power Supply**

- C1, C2 = 8 μF, 450v.
- C3 = 16-32 μF, 350v.
- C4, C5, C6, C7 = 60-250 μF, 350v.
- C8 = 30 μF, 350v.
- R1 = 100 ohms, 10w. wirewound
- R2 = 1,600 ohms, 10w. wirewound
- R3 = 10,000 ohms, 2w. carbon
- R4 = 47,000 ohms, 1w. carbon
- R5, R6, R7, R8, R9, R10 = 47,000 ohms, 5w. wirewound
- R11 = 20,000 ohms 25w. wirewound
- R12 = 5,000 ohms, 10w. wirewound
- R13, R14, R15, R16, R17, R18, R19, R20, R21, R22, R23, R24, R25, R26, R27, R28 = 220,000 ohms, ½w. carbon.
- R29 = 900 ohms, 5w.
- VR1 = 3,000 ohms, 3w.
- T1 = Secondaries 6.3v. 8A, 375-0-375v. 200mA
- T2 = Secondary 250-0-250v. 150mA
- V1, V2 = VR150/30
- V3 = VR150/30
- Ch.1 = 8H, 100mA
- MR1 = 16diodes, Westinghouse S10AR2
- MR2 = 4 diodes, Westinghouse S10AR2
- MR3 = 1 diode, Westinghouse S10AR2
- RL1 = Post Office 3000 Type: 3,000-ohm coil with 3 sets n/o contacts
- FS1 = 3A Fuse
- S1, S2 = Toggle Switch
- S3 = 2-pole 2-way ceramic switch

Composite picture to show the general construction and appearance of the HV/PSU, in its T.U. cabinet. At centre in the upper view is T1, with the relay on the right-hand bulkhead. The valves are voltage stabilisers, the rectifiers being silicon diodes—see circuit p.145. The lower view shows the simple front-panel layout.

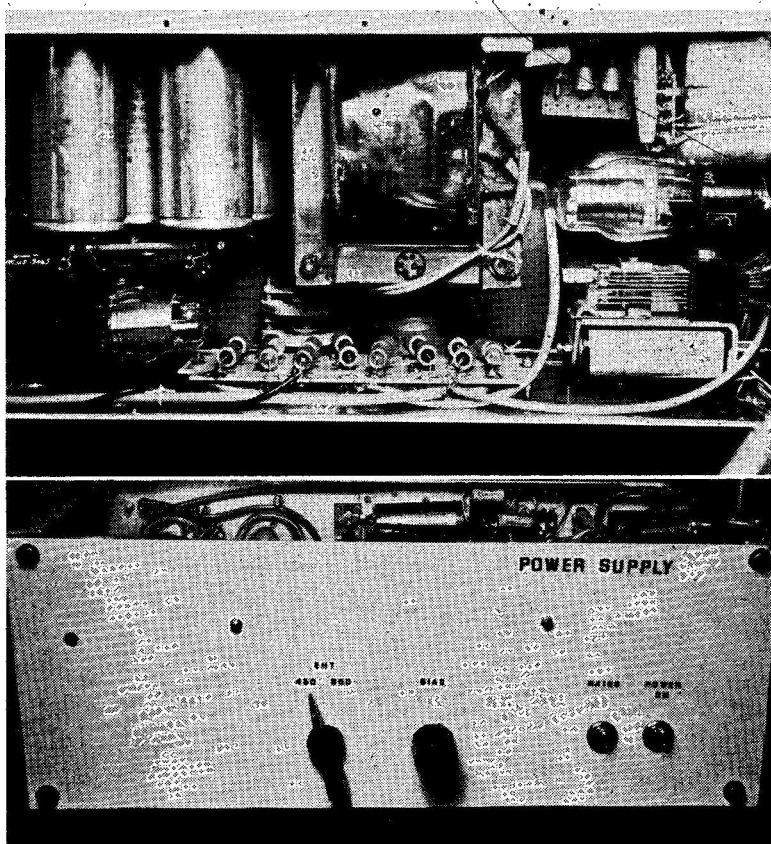

the mains voltage is applied to the transformer primary windings. It would, therefore, be very foolish to operate this power pack without the top and bottom covers screwed in position. Also remember that capacitor cans C3, C4, C5 and C6 are *highly positive with respect to earth* and are extremely dangerous.

If this power supply is built for use with an AM transmitter, then it must be appreciated that the maximum current that can be drawn from the

900/450 volt HT line is 100 mA under *continuous* conditions. Under SSB and CW operation this condition does not arise because the duty cycle (or the time during which current is being drawn by the transmitter as a function of the total time in which the transmitter is on) is relatively low. The duty-cycle varies between 40% and 65% for CW/SSB. This means that T1 can be overloaded slightly when using CW or SSB without any fear of overheating the transformer.

### F.R.S. FOR MULLARD DIRECTOR

In the list of recent elections to Fellowship of the Royal Society—one of the world's highest scientific distinctions—appears the name of Dr. F. E. Jones, MBE, managing director of Mullard, Ltd. A physics graduate of King's College, London, he had a distinguished scientific career during Hitler's War, being successively at the Air Ministry Research Establishment when it was up in Dundee, later being moved to Swanage and then to Malvern College, Worcs., where the Establishment became T.R.E. for the duration. Dr. Jones was responsible for the development of the "Oboe" precision

blind-bombing system, operated by Mosquito aircraft of Bomber Command—it was so precise that a consistent error of 600 yards on the aiming point (usually some part of Krupps Works at Essen) was found to be due to the inaccuracy of the Continental survey on which the control system was based! (The late Jerry Walker, G5JU, was in charge of the Squadron end of this operation.) Dr. Jones' main work, however, was on the operational use of millimetre-wave radar system; the development of the infra-red homing eye; and investigations into solid-state physics. After the war, he became deputy director of the Royal Aircraft Establishment, Farnborough, before joining the board of Mullard, Ltd., in 1956.

## R.220 FRONT END FOR FOUR METRES

### MODIFYING A SURPLUS ITEM

#### L. CASE

THE front-end units from R.220 VHF receivers are at the present time available on the surplus market at reasonably low prices (10s., less valves and crystal, in the writer's case) and can quite easily be set up for use as a crystal-controlled converter for the 4-metre amateur band.

The converter was originally arranged to operate with the main station receiver tuning over 5100 kc to 5700 kc as the tunable IF for 70.1 mc to 70.7 mc reception. This choice of IF proved quite satisfactory for daytime listening but after dark a great deal of IF breakthrough was experienced. This state of affairs tempted the writer to try other IF's and eventually the range 2100 kc to 2700 kc was used. Setting up procedure for both of the IF's tried is given.

Referring to Fig. 1, a 6AK5 (CV850) low-noise RF pentode is used for the RF, Mixer and IF stages, and an EF91 (CV138) in the crystal oscillator stage. The fundamental frequency of the crystal required is approximately 10.833 mc for the 5 mc IF range and 11.333 mc for the 2 mc IF. A B7G valveholder is fitted to the unit to take a crystal with the appropriate base, but as this type of unit could not be obtained cheaply a 10X holder was wired in parallel with pins 1 and 5 and left floating underneath the chassis.

To make the converter operative two extra components are required, a 2.5 mh RF choke and a 50  $\mu\mu$ F ceramic capacitor. Under the chassis there are four pins marked 1 to 4; between pins 3 and 4 fit the RF choke and then connect the inner conductor of a short length of coaxial cable to pin 4 *via* the 50  $\mu\mu$ F condenser, with the outer screening securely earthed to chassis. A suitable plug should be fitted to the other end of the coax to suit the aerial and earth sockets on the main receiver. To feed power to the unit, make up a three-cored cable and connect pin 3 to HT+ 200-250 volts; pin 1 to

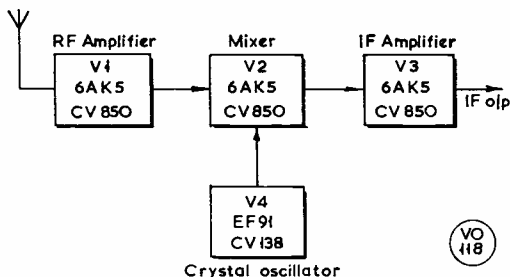

Fig. 1. Block diagram of the R.220 front end, as obtainable quite cheaply on the surplus market—see text.

12 volts AC; and chassis to HT— and one side of the LT line. The heater circuit was in fact rewired for 6.3 volts AC and is quite easily done—see Fig. 5.

#### Setting Up

All valves and the appropriate crystal unit can now be inserted. Take the IF output cable to the main receiver and connect some sort of 4-metre aerial to the socket marked Z in Fig. 2. The power can now be switched on and Osc.1 trimmer peaked for maximum output at 33.9 mc (2 mc IF) or 32.5 mc (5 mc IF) using an absorption wavemeter or, if available, the signal can be monitored on a receiver and the trimmer peaked for maximum S-meter reading. The same method is used for peaking Osc.2 but this time the trimmer is peaked at 68 mc (2 mc IF) or 65 mc (5 mc IF). The remaining trimmers—IF, C8, C2 and C1—should then be preset to the positions shown in Fig. 2 (or Fig. 3), and finally peaked, in the order above, on an incoming signal. This signal may be from a signal generator or better still an actual amateur transmission as near as possible to the centre of the band.

If no direct means of checking the oscillator outputs is available all trimmers should be positioned as in either Fig. 2 or Fig. 3 and with a little twiddling on real signals the unit should be persuaded to

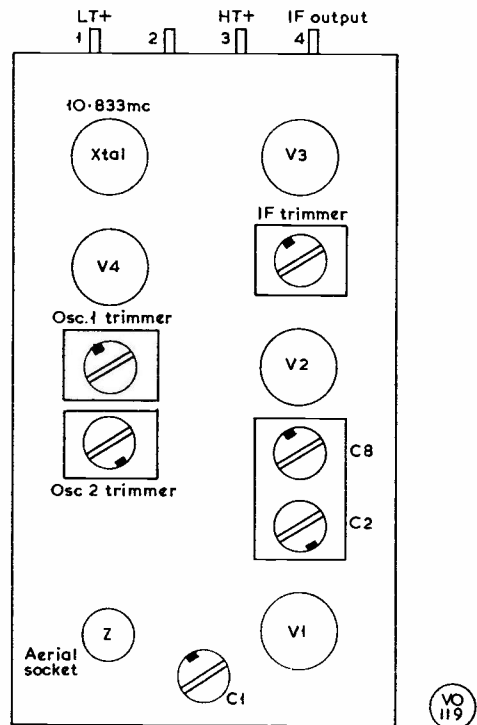

Fig. 2. Schematic of the configuration above chassis to show approximate positions of the R.220 trimmers when the 5 mc IF is used.

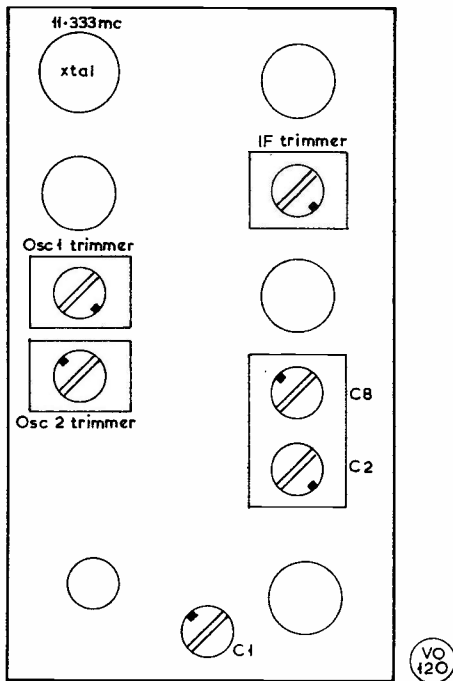

Fig. 3. This is a representation of the trimmer settings when a 2 mc IF channel is used—see text.

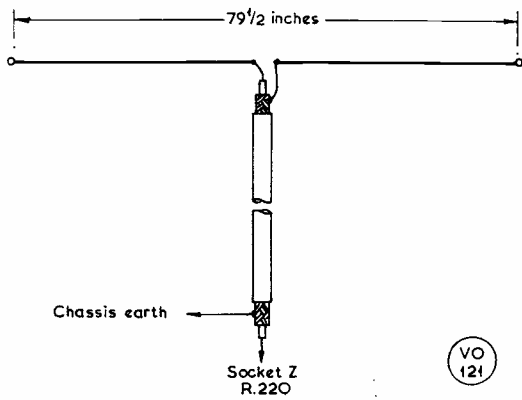

Fig. 4. This is the simplest possible aerial configuration for a 4-metre receiver. It can be put up indoors and locals up to 25 miles or so should be good signals.

perform satisfactorily.

The writer in fact tried this latter method by detuning all trimmers and, using only an electric shaver as a source of noise, managed to line it up successfully.

For the initial tests, the aerial was a simple indoor dipole of the dimensions shown in Fig. 4 which, despite its simplicity, pulled in the local stations at RS59 and stations up to 40 miles away were received at good strength.

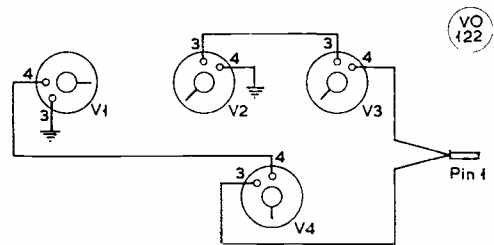

Fig. 5(a) Heaters wired for 12v AC

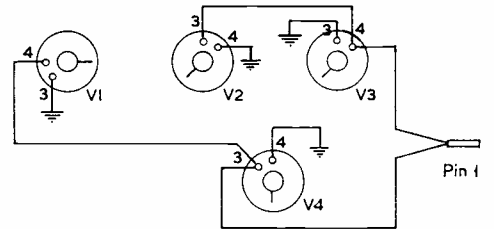

Fig. 5(b) Modified heater circuit for 6.3v AC operation

Fig. 5. The R.220 heater modifications. The (A) and (B) configurations give a choice of supply voltage.

WORTH THE MONEY

We hope! A direct subscription to SHORT WAVE MAGAZINE ensures your copy being posted the day before publication—and it should arrive, almost anywhere in the U.K., at least by the day following. Many readers write in complaining that they have great difficulty in getting the Magazine locally. There is nothing we can do about that, because all trade orders we receive are promptly dealt with—and every month we despatch literally 1,000's of copies for retail sales. What happens after despatch is outside our control. In the case of local difficulty, the solution is to take out a subscription direct with us. This costs 42s., post free, for a year of 12 issues, from the Circulation Department, Short Wave Magazine, Ltd., 55 Victoria Street, London, S.W.1.



As well as being a successful and gifted cartoonist, G3COI of Penn, Wolverhampton, builds a lot of his own gear. Here is his version—one of several ways of constructing the circuit—of the Paddington Transceiver, described in the January '67 issue of "Short Wave Magazine." It is evident that G3COI has made a very neat job of it.

## VALVE RELAY, KEY CONTROLLED

### FOR AUTOMATIC CHANGE-OVER

A KEY-OPERATED delayed-action system will commend itself to those who want break-in working without being tied to keying the oscillator stage. While the arrangement described here does not afford full break-in, in the sense that the receiving end can stop the sender whenever desired, it nevertheless contributes considerably towards the intelligent operating standard demanded by present-day conditions. It allows frequent *automatic* listening pauses during which the receiving station can indicate whether or not interference has come up.

#### The Circuit

To work the system, a separate triode valve (run off the transmitter HT because of the small current consumption), has a relay in its cathode and a delay network across its grid. To actuate the cathode relay, bias is applied to the valve by means of a small battery and one pair of auxiliary contacts fitted to the key. This cuts off the valve, which ceases to conduct, and thus activates the relay.

The main contacts are free to key any desired stage of the transmitter. Not being concerned with the formation of "dits and dahs," application of bias can also be made by a bug-key if two pairs of auxiliary contacts are fitted to an upright of insulating material held by the

paddle-screw. The cathode relay can be connected to actuate a second relay that switches off the receiver HT, swings the headphones from receiver to monitor, switches on the transmitter and changes over the aerial. If during transmission a pause is then made with the key open, the relays automatically reverse the whole process back to the "Receive" position.

#### Push to Talk

For telephony the system can be manually operated if a push-button is wired across the auxiliary contacts. Additional relays can be contrived quite easily and cheaply for the control of any additional circuits that may be required. The valve can be chosen to pass enough current to operate the cathode relay in the hold-on condition, and the actual HT voltage controlled by R3. The delay is determined by the C, R2 combination, and should be adjusted by experiment.

#### NOTE ABOUT AERIAL WIRE

For those who may not have succeeded in finding any 7/22's stranded copper aerial wire—see "Shop Around a Bit," p.725, February—a very good (or some might even say, a better) alternative is what is known in the electrical contracting trade as "earthing wire." Usually, this comes as 7/029 stranded tinned copper, in 100ft. rolls, at around 19s. retail, and is a stock item in electrical supply shops.

#### TO ALL THOSE IN FOR IT

Good luck for Friday, May 12, and may you succeed in satisfying the examiner in "Subject No. 55." What you can be sure of is that this year's R.A.E. will be a fair paper and much on the lines of previous examinations.

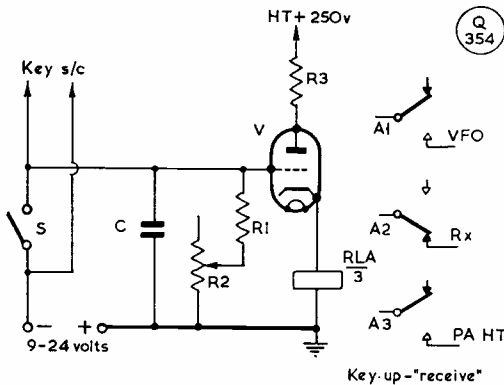

The circuit discussed in the text. Almost any valve having sufficient current-carrying capacity to actuate the relay used will do. The delay is governed by the values of C and R2, which are chosen to hold the relay in at normal keying speeds.

#### Table of Values

##### Key-Controlled Valve Relay

- |                        |  |
|------------------------|--|
| C = 0.1 to 2.0 $\mu$ F | S = Push-button switch                         |
| R1 = 500,000 ohms      | V = Any triode (see text)                      |
| R2 = 1 megohm          | Key S/C = Secondary contacts on key (see text) |
| R3 = 50,000 ohms       |  |
| Ry = Relay (see text)  |  |

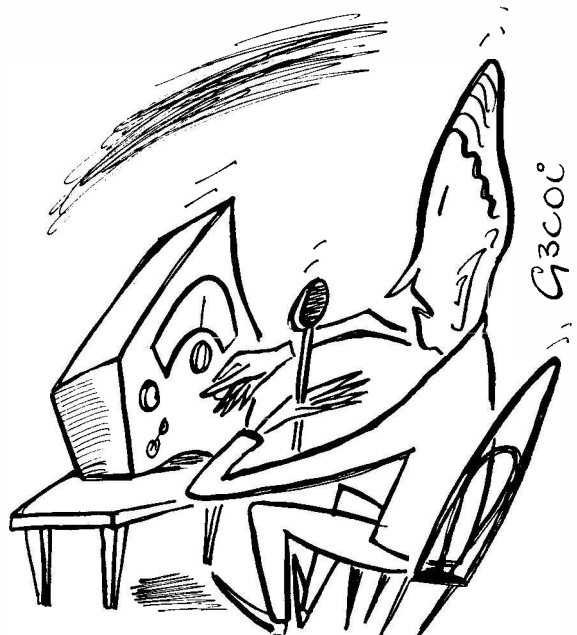

"... Everything here peaked up as sharp as it will go ..."

# COMMUNICATION and DX NEWS

*E. P. Essery, G3KFE*

**P**OSSIBLY one of the most difficult things to achieve in the context of communication and DX working is to establish a method of evaluating the performance of the rig, the aerial system, the operator, and conditions, so that it becomes possible to compare the performance of, say, an aerial with its predecessor fairly quickly and reliably. Usually such comparisons are purely subjective and qualitative, leading to such systems as the dipole at the writer's last place which seemed to work far better before it was dropped for a spot of maintenance—when it was found that one leg of the thing was disconnected from the feeder!

It does seem possible that in the new Zone scoring system, discussed last time round, the key to the problem may lie. The only real difficulty is to find some way of eliminating operator-ability from the equation—if this were possible with any degree of reliability then much good work could be done. For example, in assessing just what is the advantage or disadvantage in using a beam or a groundplane at a given location, or in measuring accurately the DX-advantage to a Top Band station of the installation of a better earthing system.

## Piracy—Yet Again

Several letters on this tiresome subject have come in during the period under review. The first is from 5X5AU, who mentions the sad state as regards the Ugandan calls to be heard on the bands at the moment. Only 5X5AU, 'JK, and 'FS are on the air, while 5X5GY is not active. Thus, the following are all phoneys: 5X5SR, 5X5CW, 5X5IV, 5X5MN, VQ5SF, VQ5X, VQ5NS, VQ5NQ, VQ5K, and VQ5ATS—the latter half-dozen are a bit out-of-date, as the prefix changed on October 9, 1962. As a matter of interest it is believed the 5X5SR—who calls himself Sid—originates from the U.K., if the beam-

heading from 5X5-land is any guide.

Another twit is making a nuisance of himself on Top Band, and pirating the call of G3BOR, who is understandably a little cross as he himself does not operate on 160 metres.

GM3IAA (Inverness) sends in a letter with a hole burnt right through the middle, surrounding the call "IS1FR," name of Ted, worked on January 13; apparently the nearest this one ever got to Sardinia was Bristol.

## Scanning the Bands

The only point at which it would be proper to start our circumambulation of the allocations is undoubtedly 28 mc. First correspondent to mention Ten is G3VDL (Chalfont St. Giles), who found it open till around 2100 on March 25 and 26, and quite active at other times. He uses 60 watts of CW fed to a dipole aerial for the band, a combination with which he raised 5N2, VP9, ZD7IP, VP7, FG7XX, and 9L1TL.

A little further north is another of the "regulars," in the person of G3VDW (Coalville), who stuck to 10 metres for the whole of the period. The result can be summed up as four new countries—EP3RO and CT2AP on Phone, and KR6AG plus HZ1AT on CW. This takes Terry up to 120 Countries in 37 Zones. In addition, he worked an assortment of W's, VE's, ZS4, CX4, PY9HL in the Matto Grosso, and our old friend G3UFO/MM on Phone, while CW yielded first contacts for the band with VK, VU3, JA, PY, UA9, UA0, and others.

Interesting details on the transmitter and aerial system from GM3JDR (Golspie) indicate that Don has a vertical and a sloped dipole, both of which are at about 10 feet above ground level, driven by a brace of 6146's at the 150-watt mark. The secret is possibly in the

location, about 100 yards from the sea, and at sea-level.

Never a dull moment with G2DC, who always has something of interest to offer. This time it is concealed in the "small print," in the way of an offering of VU2TZ on 28 mc CW—and a little later Jack mentions that Bala is in the U.K. now on a year's visit and based on Christchurch. In addition to this one Jack's other contacts on 28 mc included all of W, all VE areas apart from VE8, MP4TBO, MP4MAW, MP4BGF, VP2GLE, VP7, VP9, VS6, VS9, VK2-7, ZL1-4, ZD7IP, 5N2AAF, 5Z4KPB, 5H3KJ, and 9L1TL.

The recent spell of good conditions was good enough to attract GM3KLA (Haroldswick; Shetland) to the HF bands; Bill found 5N2AAF, ZD7IP, 9L1TL, CX1JH, HZ1AT, ZS, ZC4, ISISEL, JA, lots of odd variations on the UA theme, PY, and 5T5KG.

A K.W. Vanguard on CW, with at AR88D to receive, and a ten-metre dipole is a combination which can do remarkable things in the right hands, a pair of which belong to G3VGU (Grays, Essex), who offers CR6 and 7, CX1 and 4, PY, LU, ZS, ZC4's, 5R8CQ, 9H1, 9J2's, and the usual W's, all with the dipole at the enormous altitude of 10 feet. As this 10 metres is a band where John is free from TVI, he is naturally quite pleased at the way conditions are smartening up.

Your conductor thought the description of W6AM's aerial farm would be of interest, and sure enough it was. G3UYK (Ilford), has been at home after a spell at Stafford and in College, where the only operator of the Club station, G3VZI, has been himself — lucky chap! However the point here is that Peter has been doing some sums and compares *his* aerial farm with Don's; 1/523,000 of an acre as against 25 acres! As for results the Easter vacation period produced 5T3KG, 9G1DM, CT3AS, UF6, and OA5 on AM, with ZE,



JA, 9J2, 9L1TL, and best of all VK2NN.

Up there in Inverness, GM3IAA did a little picking, coming out of the fray with ZD7, 9J2, 6Y5, and VE6, in between spells of dodging the W's. In addition Jim mentions IS1SEL who had a lovely "organ note," no chirp or tremolo, just a nice tune, although it has to be admitted that a few days later he was heard again with a clean signal—unlike UA4KPA who was given a report of 566C by Jim and came back with "Tks fer fb rprrt!" Another Ruskie, who at least had the saving grace of a sense of humour, was trying to call WA6VLI, and sending "VV3" and then "V43" in his attempts to send "UV3." When he went over, Jim sidled up alongside the channel and sent "hi," whereupon the UV came straight back with another hi!

A man who is clearly not master of his fate is GM3JZK (Isle of Mull), who put up a ten-metre dipole and a Vee-beam for 28 mc. George made WAC in five hours on the dipole before the wind blew it down, and now finds himself ploughing the area under the far end of the Vee—there just ain't no justice in the world.

Probably the lowest aerial mentioned this month is the 10-metre dipole belonging to G3UGF (Halifax) which is producing extremely good results from a height of *three* feet; raising it to twelve feet seemed to make no measurable difference, so at the former height it stays. Richard's letter ends: "As my studies are demanding more and more of my time it will be quite a while before I have any great DX news to report, sob, sob . . ."

The West country is represented, as usual, by G3NOF (Yeovil), who mentions that all his Asiatic and VK workings have been over the short path in the mornings. Contacts on SSB were made with EP2GI, HR1KS, JA's, KØATZ (Colorado), KR6LL, MP4BEU, MP4TBO, VK's, VP1PV, VU2FN, VQ9TC, XW8AX, ZD8CX, ZS9D, 4W1G, 5R8AS, 8RIC, 9Q5EP, and a crop of W's, ZL's, ZS's and such.

Our final report on 28 mc, from GM3SVK comes not in a letter but through the "grapevine"; he found on his return up there that the weather conditions were such that



Dvoracek Jaroslav, OL4AFI, Valtirov 97, Usti N. Labem, Czechoslovakia, has made himself very well known on 160 metres. He is a consistent signal all over the U.K. and has worked stations in all parts of the country, including GI and GM. He runs a simple three-stage VFO EF80-buffer EF80-EL36 PA, and his Rx is no more than a modified R.1155. The aerial is, of course, the answer—it is an inverted-Vee, with about 120ft. in each leg. OL4AFI wants us to say, for him, that he is struggling with English, but is learning, and that he is very grateful for the excellent QSL return—he now has about 150 G cards. We gather that Dvoracek is bobbing on his full OKI licence—we would not think that there could be any difficulty about that. Incidentally, there may be some old timers who would remember the famous OK3SI, of the early 1930's, who used to be a consistent evening signal on 160m. running only 3 watts. OL4AFI is in the same tradition.

his letter would have missed the deadline, and so sent his notes by a less orthodox route. In the mornings JA's and VK's, and in the afternoon Africa and W's, is the gist of it; on CW JA5PL, and on SSB with the "new toy," a list as long as your arm, including 9M2LO, CX3BBD, CX7AP, JA2, JA5, YV4, ZL and ZS, CR6 and 5A1SV. A further list a day or so later added ZC4, EL2AF, HC1EY, and CN8FC. Who said while he was on leave that he would only use the Vespa on SSB to keep skeds, Fred? Between these four walls and the rest of the readers, we suspect Fred is hooked on the SSB drug!

As an exercise in using the new Zone scoring system (see p.92, April), colleague A.J.D. tested it out on his own results on ten metres. Running 100w. to a pair of crossed dipoles, keeping to CW and coming on for odd spells during the Easter period Friday-Monday, March 24-27, he found he had made 230 points, from 29 QSO's in 11 Zones. There is nothing particularly remarkable

about this *qua* scoring, but it does show how the system can be used for comparative evaluations.

*Late Note:* Too soon to say much about the Ten-Metre Activity Period, April 16, except that conditions were not nearly as good as they have been, though the activity was there. We will be discussing the event in greater detail next time.

#### Fifteen Metres

Continuing our tour of the field of battle, we now come to the 21 mc segment. The first missive is from GM5AFF, from RAF Edzell, who has been active since February 11, and at the time of writing, April 6, was already up to 71C worked, the only snag being of course getting them confirmed. An "interesting" opening on March 29 produced no less than 15 assorted JA's on the run. Doc's home call is W7NXJ, and this is probably the reason for his list being stronger in W7's than any your E.P.E. has ever seen; but also it includes VK's, W's, EL9A,

KR6, LU, KV4, OX5, ZC4, all on SSB, using a Swan 350 to a ground plane. In addition a DX-60 at 90 watts of CW has been used to work JA's, W7's, W6's, and a host of the rarer Russian prefixes. We suspect that Doc is acting as a catalyst at Edzell, as we hear that GM5AGM is almost ready for battle with an Eico transceiver, GM5AFJ is busily trying *not* to work all TV sets, and GM5ACE is getting down to it with a Drake TR-3; several others are on the way. In addition there is a Club in process of formation, and a club station being built—a good show all round!

One of the few to mention the gotaway tribe this month is G3VDL, who missed out on ZS8L and FO8BU. However, there was some consolation in raising TA2AC, 9J2HZ, ZL, MP4MAW, 5Z4's, VP7, 5N2, VE7, VP9, VS6FO, and KL7PI.

What sounds to have been the same weird opening to JA as that mentioned by GM5AFF is also noted by GM3JDR, who booked in 15 JA's on the run from one CQ call! W6 and 7 and VE6-7 are often quite good up until about 2100, with the South Americans hanging on somewhat later. A gotaway was VK2BRJ/VK9.

"All W and VE districts with the exception of VE8" is the first sentence of the G2DC report on the 15-metre band; Jack goes on to list FR7ZC, MP4BGF, MP4MAW, VP1, 6, 7, and 9, ZD7IP, VK, ZL, 4S7SA, 5N2AFF, 6Y5BS, 5T5KG, 9N1TL, and 9M2LO. To round off,

he mentions the evening of Saturday, April 8, when the band was open to South America and North Americans were also pounding through, with VK's and ZL's all at workable strength. The time?—2230 to 2300z!

Back up north to those two stalwarts in Unst; taking GM3KLA first, Bill worked MP4THO, VP2GLE, VK7SM, ZL4B0, VP7DX, VP9BK, 5T5KG, 9Q5TH, VS6EN, and a whole wad more. GM3SVK, also in Haroldswick is, if anything, a little further north still and is claimed to be the most northerly GM, where the mail takes three days to reach even the mainland sometimes! His report mentions VK's in the mornings, a catch of 18 JA's on the trot—wonder if they were on the same day as the others already mentioned?—and KL7, HM1CB (CW), VK9KS, VK7SM on both Phone and CW, and ZL2LH for his first contact with ZL on the 21 mc band.

G3VWC (Bishops Stortford), putting his school holidays to good account, finds the bands quite definitely in form; as far as 21 mc is concerned Andrew can only get on when the TV is off—21 mc and Channel 1 TV never *did* co-exist happily—and so has had his time severely cut back, but all the same he has worked quite a roll of DX, out of which his own prize of the month is PZ1BO, hooked on AM.

TVI is quite a general problem in the London area, and also afflicts G3VGU, who can therefore offer only PY7LAK, UC2WR, UL7KFC, UO5KBB, UR2BV, ZB2AM,

3C7CE, and an assortment of W's.

GM3JZK has been having fun on 21 mc CW, and came out with items such as 5N2, ZB2AM, VP7, 5Z4, 9V1, MP4B, VK, ZL, 5T5KG, and much else besides; on Phone, ZE's and ZS's, but CR6 and CR7 continue to escape the net, as did CE8CF in Punta Arenas for an interesting one. George mentions 6W8CD merrily dishing out numbers during BERU and concludes maybe it was the wrong Empire.

Now to G3NOF who found things pretty fair on the whole, with the band opening up as early as 0700z and giving S9 signals from VK, ZL, KL7, followed a little later by JA and VS6, all of course over the short path. W's were audible from 1130 round to midnight. Don mentions JA, OX4AA, TY5ATD, all W call areas, WØIRU/KL7, and YA1DAN.

As we said last time G3VPS (Hailsham) was preparing to return that Viceroy to owner G3MOJ. This has now happened and it is therefore a sorrowful G3VPS who writes in this month; however, a gleam of light occurred when a friend allowed him to have a little dabble /A, as a result of which 5T5 was added to the lists of the fallen.

The only mention of Fifteen in the letter from G3NWT (Risley) concerns the interlopers of commercial origin. The latest one Geoff has noted is a *thing* on 21·37 mc, which peaks when the beam is pointed to the usual direction, and sends C's at odd intervals between traffic. Geoff says *if* he could get hold of the administration concerned and the QTH of the station, the entire staff would seek new professions (this including the translator), together with a new ideology and regularised filial status. One gets the impression that G3NWT is just a *little* cross!

#### Twenty Metres

Somewhat of an anticlimax after the other two, but still performing very-nicely—thank-you as far as most of the 'chasers are concerned.

Top of the list is W6AM (Long Beach, California) who goes up one in the way of countries to 346 CW/Phone and 343 Phone only with the co-operation of 1A6SBO (Bishop Rock). An interesting sidelight on the W6AM set-up is that your conductor has never seen a report of



"... Think you must be at least two cycles low ..."

less than 5 and 9 on Don's DXCC claim copies, which seems to indicate that those rhombics really are cutting the mutton.

As far as GM5AFF was concerned 14 mc seems to have yielded less in the way of real DX than 21 mc, although Doc did find YK1AM and KR6MD worth mentioning, and doubtless hooked a lot of other things of lesser interest.

Mike, G3IAR (Sevenoaks) seems to have found his way up to Manchester, and has thus become disconnected from his records; all the same, he mentions from memory contacts with KR6AB, ZF1CG, DU1FH, VP8HJ, JY6GVM, 5T5KG, VP2GS, and all W and VE call areas, obtained during the CQ SSB Contest. During the 30 hours of operation permitted, Mike managed a total of 805 contacts.

The log of G3VDL shows quite a lot of activity on the 20-metre band although from his letter it seems his main operating times have been spent elsewhere. However, ZL, VK, 9V1's, JX5, 5H3KJ, 5N2, VP7, VP9, and MP4B all rose to the bait and were duly brought to the side.

Twenty as far as G2DC is concerned has produced its fair quota of DX within the context of a long list covering all bands. Specially mentioned on the band were all W and VE districts, plus UA0KCA, VP7DX, VP9BK, VK2-7, XE1LLN, ZL1-4, ZD7IP and 9L1TL.

GM3KLA seems to have scooped up about everything there was on offer this month on the HF bands; as witness he quotes for instance 5H3KG, VP7DX, 9L1TL, 9J2WR, ZD7IP, ZD3G, VP2's, 6W8CD,



G3VFH is the station of Lee Moore, of 9 Moor Grange View, Leeds 16, Yorkshire. Though new on the air, he has been keen on Amateur Radio for five years or so and has now graduated to the set-up shown here, involving a Heathkit DX-100U and Eddystone 640. G3VFH is a trainee technician with the G.P.O., so his radio interest ties in nicely with his work—and he is quite handy with a bug.

and much more of the same sort. Similarly, GM3SVK seems to have missed no opportunities during the short period of the month when he was on, with WA8MUF/KG6, ZD7IP, XW8's, KR6, KP4, KV4, KM6.

Coming back a few miles to the South, G3VWC does not make any specific remarks about Twenty—except to comment that he had just established that his TVI troubles were not as bad as he had at first thought, which no doubt has cheered him up quite a bit!

Ill-health has rather reduced the G4OU activity during the past month, but Fred has managed at least to keep Sheerness on the map, with quite a few nice QSO's, assorted W's including W6, various VK's, TF3, KG6AQQ, and an odd one signing W7RVA/P/LA who had plenty of takers. I6ESV was an exhibition station in Varese, and to round things off nicely, G4OU had the pleasure of hooking 5T5KG.

Some people are naturally philosophic about things; in particular, George, GM3JZK, who went back to working the EU's to get the score for 1967 up to a respectable level. In the midst of toil and travail he had the doubtful distinction of calling CQ UB5 and finding no takers! VK's, PY's, LU's, MP4B, VP9, TF3AU, VK2BRJ/9, W7AST (Montana), 4U1TU, and others were worked, the vast majority off a dipole at 30 feet.

Richard of G3UGF was rag-chewing on Twenty with a couple of DL's and commenting that the real DX—like VK and ZL—was not for the small fry; at the same time a ZL was thinking it would be nice to have some DX for breakfast . . . No further comment is needed!

Twenty seems to have been like the

THREE-BAND ZONES and COUNTRIES TABLE

Starting date: January 1, 1967

Station	7 mc		14 mc		21 mc	
	Zone pts.	Countries	Zone pts.	Countries	Zone pts.	Countries
GM3SVK	173	23	543	77	566	60
GM3JZK	135	20	429	50	404	30
G3IAR	2	3	457	55	333	26
G3VDL	86	17	390	31	315	30
G3VWC	18	4	67	7	92	6

Note: The placings this month are based on the "21 mc Zone points" column. For Zone 14 Score card on which this table is based, see p.92, April 1967 issue.

curate's egg for G3NOF. Don in fact found it good most days, with some mornings producing openings to West Coast W's and KH6, while others gave VK and ZL *via* the long path. G3STW/CN8, the Scout expedition to the Sahara, was worked on SSB; it was understood that they were not able to get permission to operate from EA9 or EAØ. Other contacts were with KG6IF, KH6's, KL7's, KR6MB, various VK's including VKØCR, VP8HZ, YA5RG, all W call areas including W5HVV/7 (Arizona), W4EFB/KH6 who used to be KA2JL, WA6ZZD/KP6, 3A2MJC, 9V1NV, and IØA.

Nice to hear from the new chaps as they get started; this month we have a letter from G3WCN (St. Helens, Lancs) who is at last able to work the stations he has been listening to for the past four years. The present machinery is an LG.50, a TA-12, and a couple of Top Band

devices on the radiating side, while reception is on an AR88. Let us hope the G3WCN rig gives its owner much pleasure and a bucketful of DX.

G3VPS (Hailsham) found his /A operations on Twenty yielded gold in the way of 4X4, HVI for a new country, UA9, W5's and W6's.

A rare one on Twenty is G3TLX, who usually does his haunting on the LF bands; thus he is able to say now that his G8KW trap aerial seems to have a liking for VK, ZL, and W on 20m. as well as on the usual stamping grounds. In addition, Ron also found UA9 and UAØ, UG6, UL7, and UF6.

An advantage of having three feeders hanging from a three-band Quad, not previously noted in the scientific literature, is commented on by G3NWT, who found that when the pole holding up his aerial broke, the combined strength of the feeders was enough to keep the aerial from actually coming right down. This saved any further damage and also enabled Geoff to gather the thing in using the feeders as halyards. Incidentally, the Quad only lasted for three S9 contacts before it fell down in an inverted position in a tangle of guys, feeders and halyards, the reason being breakage of the thinwall dural tube used for the upper support. Jamming a stout piece of timber up the broken ends inside and re-erecting gives a further short lease of life but it will come down again. The latest move has been to replace the thinwall tube with *Dural* scaffolding—about three times as thick in the wall.

#### Eighty and Forty

These two areas have been somewhat neglected by most of our correspondents, probably as much as anything because of the upswing on the HF bands.

First on the clip is GM5AFF, who managed CN8AW, 3BIFX, and EP2GL, thanks to the help of GW3AX, DJ9RQ, and G3TZH; these were of course on 80m., the mode being SSB.

"VE only on 80" bewails G3VDL, who also had a minimal amount of joy on Forty in the evenings, although early rising was more productive, yielding VP9, VP7, and 5N2, all on CW with 60 watts to dipoles.

G2DC is a chap who samples the bands frequently, and in his considered opinion all five have been doing their stuff this month. He instances on 80m. all W districts, VE1 to 4, EA9CQ, PY7AGW, ZL3FZ, ZL4IE, ZL4BO, UA9, U17, and UL7. As for 40m., all W and VE districts with the exception of W7 and VE8, MP4TBO, PY's, VP1, VP7, VP9, VK, ZL, and 5N2. Jack remarks acridly on the new "thing" which pollutes the lower 15 kc or so of the band and makes it virtually unusable until it goes to bed for the night—although one has the consolation that it must also put paid to Peking and the other intruder commercials in the process. However, the early mornings from about 0500 to 0730z, before the streets are well aired, is the time to look over Forty; all sorts of interesting things may then be audible.

The Shetland DX - hounds, GM3SVK and GM3KLA, have been leaving things alone; on 80m., Fred worked K2DGT and lost HK3AVK, while GM3KLA worked ZL4BO and lost 6W8CD. As for Forty, Bill turned in VP6AK while Fred said "Nix!"

A humorist owns the callsign G3VGU. John claims to have worked "all the QRM!" A query was the status of 4Z4NAB, who is of course one of the new issue of Israeli licences.

It does seem as though these LF bands have an effect on people and their comments often reveal it. As expressed by GM3JZK in the 7 mc context "There are better places to spend one's evenings than Forty—but the nearest is fifteen miles away!" Hence the evenings have yielded TF2WJX, a 4S7 down the drain, VQ9AR, VP6AK, ZB2AM, assorted W's and an escaped VU2, not to mention the PY stations who are classified as QRM thanks to the excellent getaway in that direction. One of the advantages of the Vec-beam is that it has excellent Boris-Vlad-and-Ivan rejection, which reduces the noise no end. Eighty was rather a tale of woe, involving winds and the force of gravity on the aerial system, albeit the emergency aerial at only 20 feet high obliged with VE1ZZ, ZB2AM, VO1AW, and various W districts.

There is no doubt that Forty in particular can do much more than it

#### TOP BAND LADDER

(G3U-- and G3V-- stations only)

Starting date, January 1, 1966

Station	Counties	Countries
G3UTS	91	15
G3VMW	83	16
G3VGR	82	15
GM3UVL	80	13
G3UBW	80	18
GW3UUZ	65	14
G3VLT	63	13
G3VES	63	16
G3VMK	61	10
G3VOK	60	14
G3UVT	57	11
G3UXP	56	9
GW3VPL	55	13
G3UGF	54	10
G3VMQ	53	14
G3UJS	51	12
G3USE	50	12
G3VSL	47	9
G3VTY	45	8
G3UGK	43	13
G3UMK	39	7
G3UCS	36	?
G3VLX	35	5
G3VSI	19	4

## Reporting the HF Bands

is generally credited with, as the few who really study it have already found. G3VRZ, who hails from Birmingham, runs 150 watts to a homebrew transmitter, with an AR88 Rx and a dipole as the radiating element; Hugh has been working PY's, XE2AA, W6 and all the other W districts, HI3PC, UH8CS, and, biggest thrill of the lot, VK3APN, all on CW. As for the list of the escapers, this includes 9Y4DS and CO3CS.

QRP on 80m. has amused Ron, G3TLX, who managed W2LXX and ZL4IE with an input of just one watt to a G8KW trap aerial. Others, worked with normal input power, included YN1CW, ZL's, all W districts (with the exception of W7) VE1, 2, and 3, VO, UL7, UA9's, VP7DX, HI8XAL, and an OHØ. Gotaways were FG7XM and VP1AA; the former did not seem to be working anyone much, although he was putting down quite a good signal in the U.K. when your conductor—and several others—heard him. On Forty, Ron mentions all W call areas, KZ5, 9Y4DS, VO, UA9, UL7, UF6 as worked, with an XE heard.

We now hear that G3SED (Portsmouth) has transferred his affections from Top Band. Mike has been enjoying the Phone on the band during the day, but has yet to get the feel of it as far as CW operation is concerned. So far ZL4IE, PY1BTX, YN1CW, VE's and W's have been worked, although Mike says almost every other W is an old Top Band friend who promptly suggests a QSY to 160!

Just back with the Luton Lot from their Guernsey expedition, G3VES (Luton) found that the remaining half of his broken 160m. inverted-V left him enough wire for the same sort of configuration on 80 metres. Moving the VFO to 1.75 mc and doubling the PA in its pi-tank produced W1-4, VE and VO, with 15 watts only—nice going.

### Top Band

Reading through the mail, one is struck every month by the difference

in style between the letters discussing different bands—the HF bands, sharp and to the point, the Top Band ones amiable, friendly and almost "personal," with few exceptions. Thus it always has been on Top Band itself, which is probably the reason for the individual charm of the band, causing folk to become addicted to it to the exclusion of all other forms of Amateur Radio activity.

However, the main letter this month must undoubtedly be the short snappy one from VK3BM (Quambatook, Victoria) who worked DL9KRA on the morning of March 18, the actual operating on this occasion being done by VK2AVA who was visiting at the time—which was 2015 GMT, the reports 339 and 229. His previous DX contact in the log was G3FPQ on March 6, 1965, so Bruce rubs it in that he does not like either CW or early rising! On the other hand SSB is worked fairly often on 160 metres and another

"first" for VK3BM was the W/VK QSO on SSB, a feat which has been repeated several times since. As to the gear used on Top Band, Bruce runs a Swan 140 converted, a homebrew linear, and a 75A4 on the receiving side. For aerial he has a full-size groundplane, with a 136-foot vertical and 16 radials at ten feet above ground level! At DL9KRA, Drake gear and a long-wire 110 feet high was used.

With the help of a different VFO and a larger power pack G3VMW (Ossett) has had the odd contact on Eighty, but he still keeps to Top Band, on which he has hooked four more counties. Due to the pressure of work from exams which are coming up Steve has had little time to spare and so of course he finds the going a bit tough so near the top of the table.

Another who has been rather less active than usual is GW3UUZ (Llantwit Major) who has been somewhat disorganised by contractors modernising the lighting system in his lighthouse eyrie, and by spring-cleaning as well.

As already remarked, G3VPS has had his activities on the HF bands rather reduced, but he has had the



The station (and family) of ST2SA, Dr. Sid Ahmed Abrihim, Port Sudan Hospital, Sudan, who runs the only legit. ST2 station in actual operation. His gear consists of a Lafayette HA-350 and Heathkit DX-40U driving a 2807 PA to 150 watts, into a dipole—all on 15 metres, on which band ST2SA uses both AM and CW. He has been a reader of "Short Wave Magazine" for some years now, and is always ready for contacts with the U.K.—and as well as being DX to us, his prefix is also something of a rarity.

odd QSO on Top Band using a home-brew transmitter. He was a little startled to hear a Top Band operator moaning that he was "fed up with working W's one after the other"—as G3VPS says, the height of his desire is to work one, let alone a string of them!

The gear at G3VGR (Southend-on-Sea) comprises the G3RNL transistorised VFO in conjunction with the Mini-Five exciter, as described in *SHORT WAVE MAGAZINE*, which seems to work so well that Dave has found no need for a linear.

G3VLX (Sidcup) has somewhat altered the emphasis in his operating to working G semi-DX on Phone, and has had a lot of fun in the process; the only DX contact Deryck mentions on the key this time is his QSO with DL1FF, which resulted from an early-morning session.

It rather sounds as though G3VLT is about to turn traitor and join the ranks of the VHF addicts, as he has been busy building an FET converter for 70 mc; however the odd QSO on Top Band has netted him several new counties and some new countries, to the benefit of his Table standing.

To judge by the first paragraph of his letter, one would think that G3TXS (Rainham) has been shooting, unsuccessfully, at the moon; however, what it means is that Dave has achieved his ambition at last. For two years, ever since he has been licensed, his ambition has been to work across the Atlantic. This he finally achieved recently, when he stayed up late and at 0200 raised VO1FB. Some sixth sense at that stage told him to stick around and an hour later the band opened more, a contact with W1BB/1 following at 0445. Just to cap it all, at 0610 K1PBW came back to a CQ DX call with a report of RST 349. As we already have remarked, G3TXS regards himself as being in the tiddlers class—and yet, with these contacts, Dave is able to put in an entry at 89 counties, 18 countries, which is pretty good—possibly a big tiddler?

Rearrangement of the shack consequent upon the acquisition of a Minimitter Mercury at G3SVW (Manchester) entailed the construction of stronger benches (and bigger!) so that the only activity of late has been operation in all the Top Band contests, either /A or for the South

Manchester boys using G3FVA/A, the Club call. Ron is now almost finished with the reconstruction and should therefore soon be making an appearance in the HF band Tables.

Just about everyone has heard GM3SVK with his new Vespa SSB on the band, but G3VYF (Hornsey) not only worked Fred, but also had an all-night session with him while GM3SVK was on his recent spell of leave; between them they hooked ZB2AP, W2EQS, W1BB/1 and a lot of GDY signals. Mike is another one to have acquired HF gear and proposes to leave Top Band severely alone for the summer.

G3UBW seems to have been on the GD6UW expedition, and writes in with an amendment to his scores, thanks to the week or so of operating at home which followed the trip. GM3UVL (Glasgow) spent most of his time on the new all-band rig, which is now "perking" on crystals; the VFO will probably be done by the time this is read. Bill worked a couple of new counties over Easter, but was mortified to discover one of them does not QSL!

The present score of G3VTY (Leeds) who was licensed in October last year, is 45 counties and 8 countries. Keith uses a 52 Set which has been worked over to improve the performance, in conjunction with a home-brewed transmitter. The aerial is a *folded* quarter wave of 300-ohm ribbon at a height of about 25 feet.

Phil of G3VMQ has been told that

his W7 contact was probably a phoney, the assumption being that W7 is *only* to be found on the 1875-1900 kc segment of the band, which does not tie up with the list of frequency allocations shown in the 1967 *ARRL Handbook*. Perhaps G3VMQ will resolve this one once and for all by the receipt of a card—and what better way?

Various correspondents this month, including G3UTS (Newcastle-on-Tyne) mention the shortage of Herefordshire, and of Huntingdon, in the line of counties. However, Reg is a little off the beam when he says it is too small to put a half-wave up in Herefordshire, and our guess is that he was thinking of Rutland.

G8HX (Mansfield, Notts) is an exclusively Top Band man, who writes in to stake a claim in the Table, and to add a few of his own brand of pungent comments on this-and-that. Frank makes the *very* valid point that the best filter is the grey jelly stuff between the ears—while a crystal filter does not improve with use the grey jelly most certainly does!

#### This and That

G3NWT remarks on a VK4 who had a signal which peaked on the beam when the beam pointed at ZS, which area he was working, and a ZS who similarly peaked in the direction of PY. The odd thing is that in each case the beam-heading at the maximum intersected the Great Circle line between the two

### FIVE-BAND DX TABLE

(New Cycle)

Starting date: January 1, 1967

Station	Countries	28 mc	21 mc	14 mc	7 mc	3.5 mc
G3IAR	115	24	51	76	35	48
GM3KLA	88	23	16	44	30	43
G8DI	82	16	43	56	17	19
GM3SVK	106	15	66	77	23	12
GM3JZK	75	30	30	50	20	10
G13GTR	44	1	12	35	12	9
G3VWC	33	2	16	15	22	5
G3VDL	60	19	30	31	17	4
GM3JDR	91	—	80	31	—	—

Note: Placings this month are based on the "3.5 mc" column.

ends of the QSO, which would suggest that side scatter was occurring. Geoff is also very pertinent when he remarks that when all other signals can be peaked by turning the beam in the direction indicated by the *Zone Map* it is a little disconcerting to find a DX-pedition which peaks no less than 20 degrees off the line — sometimes known as the “comfortable mainland hotel effect!”

G3IDG has recently had a letter from VE7BS who comments that about 400 VE7's show their call on the licence plate of their cars; the privilege is conditional upon the carrying of mobile gear in the car. One cannot help wondering how many G/M's could meet the requirement.

Very nice to hear from 7Q7LZ (Mzuzu, Malawi) who used to be G3LZZ. Andrew mentions that he is active on all bands 80-10m., with a G5RV aerial, which he hopes soon to augment by the acquisition and erection of a Thunderbird TH4 beam, which should make things perk up a bit.

Just as this was going down, in came an interesting letter from G3UFO/MM, m.v. *Clan Malcolm*, GVVQ, posting from Naples on a voyage to Australia. The ship is expected to be in Sydney by May 22, to load for the U.K. and a spell of home leave early in August. Since his ship left Glasgow in November, G3UFO/MM has worked about 300 different amateur stations in 76 countries—and most of his amateur-band time has been spent listening for G's. G3UFO/MM has not him-

self yet worked any other G/MM's, though G3SPS/MM is known to be active and has also been working U.K. stations. While on passage to VK, David will be on the look-out for G contacts, and will listen on Top Band—G3SED may be interested to know that he was heard off St. Helena, in the South Atlantic, when on the outward leg of the voyage. Incidentally, G3UFO was married last February and is “shocked” to find that his XYL is planning to become a licensed AT-operator herself. (It should result in some interesting sked QSO's!)

#### Some DX-Peditions

The Irish Radio Transmitters Society will be running a trip to Bere (pronounced *Bear*) Island in Bantry Bay, where a Spanish treasure galleon is reputed to have sunk when the Armada was scattered—but they are after a different sort of treasure, in the way of QSO's. Look out for EIØBI on all bands Top to Ten, all modes AM/CW/SSB, and send your QSL's to EI2AW (*QTHR*) who is looking after the whole QSL chore.

It is said that K6CAA is going to the Pacific during the late summer, to Phoenix Isles, VR1. The cards will be handled by K9OTB. Another American affair is that of WA6SBO, who has a trimaran built up and almost ready for a trip which is planned to last four or five years, with many rare and new spots in the itinerary; it is believed that the length of each stop will be enough to allow a sporting chance of a

contact to everyone.

Lloyd and Iris Colvin have been stirring the bands up very well indeed from 5T5KG, and by the time this piece gets to print they are expected to show up with a TZ call.

#### Prefixes and Things

For years now the Italians have been most conservative about their prefixes, but recently there seems to have been a rash of variations on the theme from I1 right through to IØ, with the sole exception of I5—which used in any case to be the prefix for Italian Somaliland.

A new prefix which may appear on the bands in due course is 8Q which has been officially allocated, so we understand, to the Maldive Islands, in the Indian Ocean.

\* \* \*

And there you have it. Thanks to all our correspondents, also the *DX News Sheet*, W1WY, W6AM, the grape-vine and all the sources which have been tapped to produce this piece. Letters for our next should be posted to arrive by **Monday, May 8**—and for the *July* issue (and those who come in by airmail) the closing date will be **June 12**. Correspondents are particularly asked to note that the only QTH for the feature is as we give it here: CDXN, SHORT WAVE MAGAZINE, BUCKINGHAM, ENGLAND. Letters should *not* be addressed direct to G3KFE, nor in any other way. (There are internal admin. reasons for this.) Till next time, then, *73 es DX*.

#### WEST COUNTRY OIL DISASTER

When a fine new ship was put on the Seven Stones, to spew her cargo of crude oil over the sea, the first real situation arose in which the Radio Amateur Emergency Network—inaugurated in August 1956—could be brought into action. The picture on the right is not just another /M, but Geoff Cooper, G3VJB/M, one of the RAEN mobiles available down there.

The local “Raynet” organisation was called on for duty by the Superintendent, Newquay Police, on Tuesday, March 28, and asked to provide communication between the control centre (Newquay Council Chambers) and the scenes of action. Thereafter, until Thursday, April 6, the amateur /M's maintained radio contact, often from almost inaccessible beaches. Some members of the group had to make long journeys to be in Newquay for their spells of duty.

Not unnaturally, the local authorities responsible for dealing with the pollution were very surprised and most gratified to find that such competent radio amateur

assistance could be conjured up, apparently from nowhere. Well done, boys!



G3VJB of Newquay working the RAEN base control station during the oil-pollution operations down there recently. Drums of the detergent used can be seen to the left of the car.

# VHF BANDS

A. J. Devon

IT has again been a period during which there have been only flashes of openings—indeed, as this offering was being prepared, there was talk of “an anti-cyclone centred over the English Channel,” which ought to have produced some GDX and a little local EDX.

However, it was on March 21—just too late to catch the April deadline—that things really opened to the south, bringing in F's right down to the Pyrénées. About 2300z, G6NB (Brill, Bucks.) worked first F9NL in Bagnères-de-Bigorre and then EA2DS, Bilbao, in the Spanish iron-ore town to the east of Santander, fronting the Bay of Biscay. Bill says that this fine opportunity for EDX was almost completely missed. Very few people appeared to realise that the band was wide open. Of course, this is not the first EA/G contact on two metres—G2JF achieved that on June 11, 1964, with EA1AB (Santander), and in somewhat similar circumstances, in the sense that it was something of a fleeting opportunity.

And now we can look much further in the way of DX even than that—for on April 16, 1700-1800z, G3LTF worked W2IMU/2 by E-M-E (moon reflection), on 432.00 mc. Naturally, this was the outcome of a carefully prepared sked arrangement, starting on April 15, with 28.9 mc as the talking channel for liaison. On this Saturday, signals were heard both ways, but weakly and in the noise, no QSO resulting. Peter juggled with the little dipole in the eye of his 16ft. dish, and was then getting W2IMU/2—running 400w. RF into a 60ft. paraboloid—at about 12-15 dB over noise. During this session, W2IMU/2 worked HB9RG (also a dab-hand at E-M-E). The contact on Sunday, April 16, for G3LTF/W2IMU was 339/439, with marked QSB. But by the end it was a solid QSO, right to the exchange of 73. It is also known that on the 16th

PE1PL/W2IMU heard one another, without an actual QSO. On the Rx side, G3LTF was using a new TIXM-05 transistor pre-amp., the converter giving an overall noise figure of 2.5 dB. From the Tx, Peter gets 500w. RF out, with a planned increase to 750w. (You need power to get along this 477,680-mile path, with only an unstable reflector at the mid-way point!)

A further sked had been fixed for the weekend April 22/23, late evening, so we shall not be able to discuss any further results till next time. After about 18 months waiting for a real DX opportunity, G3LTF of Galleywood, Chelmsford, is back in the moon-bounce business, with a new success scored and more laurels on his brow. Well done, Peter!

\* \* \*

Forthcoming DX-peditions include an I.R.T.S. station signing EIØBI, June 3-5, from Bere Is., Bantry Bay, Co. Cork, on 70.26 mc; arrangements with EI4BK, Limerick.

From the City University, London, E.C.1, a three-band expedition, 70cm.-2m.-4m., will be going to Breconshire for the week August 30-September 6, signing GW3UCU/P, and skeds are invited via G3VFD, QTHR.

As regards DX-pedition results, the G6UW boys (signing GD3SKT from Snaefell) kept hard at it over Easter and registered some successes, though conditions generally were not too good for them—indeed, they were not easy to work from the London area, and it was mainly weak CW both ways. One outstanding success (for both sides) was a contact G3LTF/GD3SKT on 70 cm., but signals were only 329 both ways, and one suspects that it was Peter's dish that was doing the work. During the GD3SKT appearance, it was interesting to hear a number of OT's—including G2NH, G5DF, G5MA, G5NU and G6RH—busy keeping their two-metre skeds with Snaefell.

Also over Easter, the Dorking group were in Rutland, with G3TDB/P on 4m. and G8ARH/P on 70 cm. The local TV/Tx put paid to any 4-metre operation

(future expeditionaries to note!) but G8ARH/P did quite well on the 430 mc band, working several stations at distances up to 200 miles or so.

\* \* \*

An interesting report about the 4-metre beacon ZB2VHF, on 70.26 mc (same freq. as EIØBI)—it has been heard by G3FDW, up in Retford, Notts. (date and time not stated, but presumably during the period). Informed opinion is that the 4-metre band should be workable G/ZB2 any time during the next two or three weeks! ZB2AP is the active chap down there, and can be found on ten metres (for checking the possibilities) most evenings—28.05 mc CW, from 1800z.

Also on the DX theme, 9L1HX is building for *Oscar V*, and his gear will include a 90w. CW Tx, a crossed-Yagi array and a good

## TWO METRES

COUNTIES WORKED SINCE  
SEPTEMBER 1, 1966

Starting Figure, 14  
From Home QTH only

Worked	Station
47	G5NU
45	G3FDW
42	G3DAH
41	G3COJ
36	G3FIJ (115)
33	G3FNM
31	EI2A
29	G2AXI, G3SZX (75), G3USF (186)
28	G3TQZ, G5UM (147)
22	G2CDX, G3TDL
20	G3IOE
19	G3FVC
17	GW3CBY (65)
15	G3KQF, G8VN (76)

This annual Counties Worked Table will run till August 31, 1967. All two-metre operators who work 14 or more Counties on the band are eligible for entry. QSL cards or other proofs are not required. After the first 14 worked, simply claim from time to time with counties as they accrue, giving callign and date for the county worked. Total of stations worked in excess of 50S may also be claimed and will be shown in brackets after callign. To keep the Table up-to-date, claims should be made at frequent intervals.



converter. So when the next satellite operation gets under way, 9L1 will be a serious possibility.

\* \* \*

Next VHF meetings are, for the South-East UHF/VHF Group, on May 12 at Wye College, Ashford, Kent (membership open to all interested; hon. sec., G3DAH, QTHR). And for the South Wales VHF Group, on May 23, at GW4CG, 20 Austin Avenue, Newton, Porthcawl, Glam.

The London VHF Convention is on May 13, at the Winning Post Hotel, Whitton, Twickenham—tickets 30s. (convention and dinner) from G3GMY, QTHR.

\* \* \*

In a comprehensive comment, Tom Douglas, G3BA, of Sutton Coldfield, fills us in on the general VHF situation in the Midlands. As regards 4 metres, activity is too low, though Sunday mornings will always produce a few "die-hard signals," with G3RWM/M and G8VN/M out on high ground. A test with EI7AF was interesting, in that something was heard both ways, but no QSO. As for two

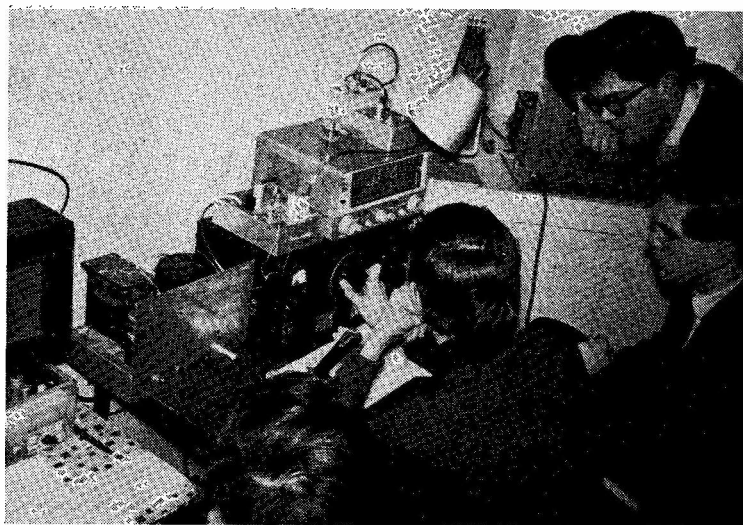

The Liverpool University VHF group sign G3OUL and operate from their observatory tower, 150ft. above ground level. Gear includes a transverter 4X150A PA driven to 200 watts p.e.p. on two metres from a KW-2000; a TW-2 and a G. & D. converter; and they are "fully transceive" on 145.41 mc. A regular Monday-evening sked is kept at 8 o'clock with G3SHK (Ruislip, Middx.), and calls are welcomed afterwards from anyone else on the band.

metres, the Sideband net on Monday evenings can result in as many as 20 stations coming on at odd times—as Tom says,

though it may be rather like working an SSB net on 80m., it is two metres and some of them are over 100 miles away, with no QRM (except from each other) and little QSB.

The two-metre beacons are a sore point around Birmingham way. Wrotham is reliable and useful but the Cornish beacon can often not be heard even when there are signals coming through from those parts—GB3CTC seems to have lost much of its potency since the rebuild to include 70 cm. The GI beacon, GB3BI, cannot be found at all unless the two-metre band is open in that direction, the same applying to the GB3GW marker from Swansea. Well, when they can be heard, they certainly prove the band condition . . .

**Dead-Line**

The hard news came in just as it was time to get into print, and with the space already allocated, much has had to be left unsaid—apologies to numerous correspondents! For our next, the deadline must be **Monday, May 15**, to: A. J. Devon, SHORT WAVE MAGAZINE, BUCKINGHAM, 73 de A.J.D.

**THREE-BAND ANNUAL VHF TABLE**

*September 1966 to August 1967*

Station	FOUR METRES		TWO METRES		70 CENTIMETRES		TOTAL pts.
	Counties	Countries	Counties	Countries	Counties	Countries	
G3EDD	27	3	47	9	32	5	123
G3LAS	28	3	38	8	14	2	93
G3FIJ	29	5	36	8	6	3	87
G3BNL	15	2	16	3	28	2	66
G5FK	26	3	13	4	13	2	61
G3AHB	11	2	26	4	12	2	57
G5UM	13	2	28	2	11	1	57
G2AXI	15	2	29	10	—	—	56
G3TLB	9	2	39	6	—	—	56
G3EKP	20	6	12	4	8	3	53
EI6AS	13	6	17	5	3	2	46
EI2A	5	2	31	7	—	—	45
GW3CBY	4	2	17	4	6	2	35
G3KQF	—	—	15	6	10	2	33

Scores are since September 1, 1966, and will accrue until August 31, 1967. Position is shown by last-column total as aggregate of all scores. Own county and country score as one each. Entries may be made for a single band any two or all three. Claims should be sent in as often as possible, to keep the Table up-to-date.

## MOBILE AERIAL DESIGN FOR TOP BAND

### ARRIVING AT THE MOST EFFICIENT INSTALLATION

*This article represents the fruit of original work carried out some time ago. It is offered in response to many requests and suggestions, as well as queries of the kind which show that the principles involved are worth discussing again. It is also evident that there is much scope for the investigation of mobile aerial design, performance and construction.—Editor.*

SOME first rather hit-or-miss tests with a loaded whip—which can be defined as a rod aerial brought to resonance by means of a series loading coil, the whole mounted vertically and fed at low impedance—soon showed that unless the aerial was right, nothing could be expected in the way of  $I/M$  results beyond local ranges of a few miles.

It was also found, that by means of a  $\pi$ -section coupler, it is quite easy to load up on a vertical rod of, say, 8-10 feet in length, having a loading coil of some random dimension in series such that the system as a whole can be made to draw power. Over short distances up to five or seven miles, quite impressive results can be obtained with such an arrangement—anyway, good enough to impress a beginner in the mobile art.

But, as this article will endeavour to show, there is much more to it than that. The radiating efficiency of a simple end-fed system, in this context, is, in fact, very poor; range falls off rapidly, and it becomes exceedingly difficult to keep the output tuning at resonance. This is in spite of the fact that RF and plate meter indications would suggest that the system is working quite well.

#### Aerial Loading Characteristic

The reason why the arrangement is not really effective is because the aerial is working as a resonant end-on—that is, as an aerial very short in relation to the frequency and poked out, as it were, from the earthy mass of the vehicle. This is a very different thing from making the aerial a resonant quarter-wave, with the car body and its capacity to ground as the “other half” of the radiating system.

What it comes to is that, for really satisfying results, one must aim for an effect akin to the ground-plane mode. In this, the whip-plus-loading coil is one element in the system and the car body with its own capacity to ground the other.

If this condition is achieved, the radiating efficiency goes up considerably and the whole aerial system, as a load on the transmitter, becomes much more docile and consistent. The problem is, therefore, to avoid tuning to the resonant end-on condition and to find the ground-plane mode.

In general, it can be stated that the ground-plane effect is present when the system is being fed at maximum current with a coil of reasonable dimensions in series with the whip. (At this stage, what is meant by “reasonable dimensions” is a coil which looks as if it should tune the 160-metre band.) It is easy to check on the mode, whether end-fed or ground-plane, by using an RF meter in the aerial feed lead: Assuming that we should be looking into an impedance of about 40 ohms for a quarter-wave GP system and knowing the RF output (taking 75% of PA input),  $I^2R=W$  can be used to determine whether the aerial current is what it should be for that sort of impedance with the RF power available.

For example: With 4 watts PA input, the RF output into the aerial can be taken as 3 watts; if the feed impedance is 40 ohms, the current in the RF ammeter should be about 0.27 amps. If it is more than this, the feed impedance is less than 40 ohms (which it very well might be in some cases, as the figure can vary from 25 to 50 ohms). But if the ammeter reading obtainable is not greater than, say, 0.12 amps, it will be evident, from  $I^2R=W$ , that the feed impedance is much higher than 50 ohms, and the mode at which the system is operating is not ground-plane at all but resonant end-on—the one to avoid.

It is also possible to detect the ground-plane effect without an RF meter, by noting the behaviour of the variable condenser on the output, or “draw,” side of the  $\pi$ -coupler. In the end-on condition, this will tune very sharply and will react strongly on the setting of the “resonating” capacity on the plate side of the coupler. On the other hand, when the low-impedance mode is found, the “draw” condenser will be quite flat in its adjustment while the “resonate” capacity will not be much affected by changes in loading.

#### First Results

That the ground-plane mode is more effective is proved by the fact that on distance tests—working from the same point with the same transmitter at the same input, with constant conditions at the receiving end—the comparative S-meter readings with the GP system were some 25 dB up on the end-on aerial.

Having got thus far, it was decided that it could only be the first step in a comprehensive test programme. The next, and even more important, move was to try to determine the behaviour of different types of resonated whip aerial when operated in the true ground-plane mode.

#### The Test Set-Up

This consisted of various lengths of copperised-steel whip section; a coil  $13\frac{1}{2}$  in. long by  $1\frac{1}{2}$  in. in diameter, wound full of 20g. DCC, with some 20 tapping points including a selection of 5's and 1's, this being insulated at each end, with mounts to take the whip sections; a wide-range calibrated GDO and power supply; a tunable field-strength indicator having an 0-100  $\mu A$  scale; the car with which the tests were to be conducted, having the aerial mount

on the offside of the rear bumper bar; and a receiver with an S-meter calibrated to S9+50 dB.

The GDO, fitted with a 3-turn loop probe, was coupled into the base of the aerial by a few turns of wire, just enough to give an indication of resonance; one end of the coupling loop went to the insulated metal aerial mount, the other side to car chassis.— See Fig. 3, p.163.

Throughout the tests, the same equipment was used, with constant coupling and the same relative positioning at a fixed distance of 50 feet from the receiver. It was found that adequate signal could be obtained off the test aerials, fed only by the GDO, with about 10 feet of wire on the receiver. It was this that greatly facilitated matters, since it was possible to sweep a wide range of frequencies at constant input, and to see from the receiver S-meter exactly how the aerial on test was behaving.

### Interpretation of the Curves

The plottings in Fig. 1 show the results obtained with three different aerial arrangements. In (A), the length overall, including the coil, was 7ft. 9in.; in (B) the 2ft. 6in. top length was fitted on the coil like a T, with the horizontal section at 90° to the length of the car giving an overall height of 5ft. 3in.; in (C), the 5ft. 9in. top projected above the coil in the conventional manner, height overall then being 11 feet.

In all three cases, the inductance value was kept constant, the point of resonance being found on the GDO and then measured on the receiver, which also gave the peak S-values. The resonance curve in each instance was plotted by moving the GDO in steps of 10-20 kc at a time, on each side of resonance.

There are several interesting points to notice about these curves. In the first place, they show very well how sharply a loaded whip resonates; in (A), (B) or (C) a move of only 10 kc off resonance results in a marked decrease in signal strength. Secondly, the shape of the curves is consistent (incidentally, this is a cross-check on the method of taking the readings, and therefore on the validity of the whole experiment). Thirdly, with aerial (A) the resonance point was moved 40 kc LF of (C); this by the mere shortening of the top section from 5ft. 9in. to 2ft. 6in. By making this short top horizontal, the frequency went 10 kc HF.

Fourthly, the superiority of the (C) arrangement is very evident, not only in terms of higher peak signal level, but in the width of the curve above the S9-line; at the same time, the peak at resonance is just as sharp as with the others.

Explaining the apparent anomaly of a lower frequency with a shortened top (one might have expected the frequency to go HF), this would seem to be due to an increase in the capacity of the system as a whole with respect to the car; the longer top tends to distribute this capacity more. The result as between (A) and (B) supports this conclusion, since the (B) arrangement represented a decrease in capacity with respect to the car body.

The (A), (B) and (C) peak readings were also noted on the F/S meter, set up at a distance of 10

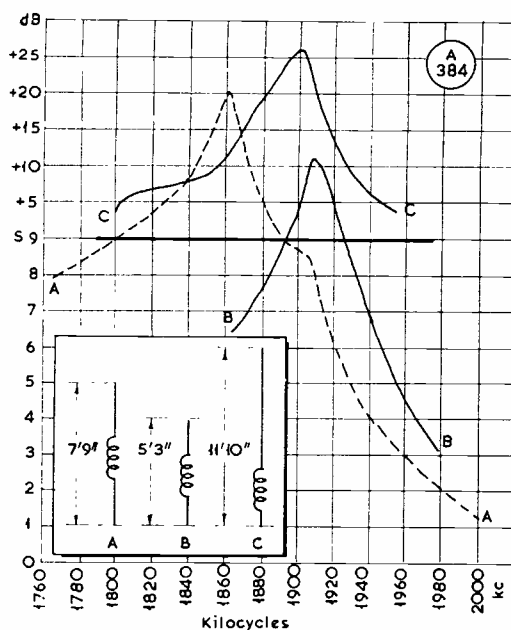

Fig. 1. The resonance curves obtained on three different aerial configurations—see text. They show how sharply a loaded whip tunes when correctly adjusted. For each end-section length, the inductance value was held constant, to check how the point of resonance moved with different lengths of top section.

feet from the aerial; they followed the peaks shown in Fig. 1. All the readings were higher than those obtained with the aerial in the original end-on resonance condition.

### Results on the Air

So much for theory and paper-work. The next thing was to test Fig. 1 over a distance of miles instead of yards, to see how these aerials compared under actual radiating conditions—in the clear, and away from the possible local effects of a complex of radiating systems, involving feeder lines and stay wires which could conceivably be affecting the results as graphed in Fig. 1.

For the radiating tests, the transmitter was xtal controlled on 1896 kc, running 5 watts input. For the purpose of the tests, this transmitter was regarded merely as an RF generator, capable of a constant output at fixed frequency, to feed power into the test aerials.

The location for the distant tests could not confuse the issue in any way, because it was three miles away and right in the clear, with no local obstructions of any sort. It was selected as a convenient reference point from which all measurements could be taken.

Results obtained were exactly in accordance with those to be expected from Fig 1. With constant receiver settings, Aerial (C) gave S9+22 dB, Aerial (A) S9+16 dB, and Aerial (B) S9+10 dB. At the

test site, readings on the F/S meter also corresponded to these results, e.g., with Aerial (C) the field-strength meter, at a distance of 10 feet, gave the highest reading.

While these results were as expected, they are yet of considerable experimental interest, because they prove that readings obtained using the GDO as the energising source, with a local receiver to compare radiating efficiency, can be taken as a reliable guide to what should happen under "real" conditions. This is a result worth bearing in mind by those who may be casting about for some certain method of setting up and resonating a whip aerial system on Top Band.

### The Capacity Hat

It being by now evident that the critical factor was the length of top above the loading coil, a capacity hat was tried under a variety of conditions. The hat itself consisted of a 12in. diameter stiff wire ring, supported from the centre by four radial wires, mounting on the whip being by collar and grub screw, to allow the vertical positioning of the hat to be varied.

The first test was to determine the effect of the capacity hat on the resonant frequency. Results were surprising. With the 5ft. 9in. top and resonance adjusted to 1900 kc, fixing the hat 2ft. above the loading coil moved the point of resonance to 1750 kc; at 12 inches above the coil it was 1740 kc; and right on the coil, 1730 kc. In other words, the position of the hat above the coil was not critical, though at any setting it had a very marked effect on the resonant frequency as between hat and no-hat.

An even more surprising result was the effect of the capacity hat when tried with the short (2ft. 6in.) whip section above the loading coil. The resonant frequency was moved only a matter of 20 kc LF, to 1880 kc.

Resonance curves were then plotted, and are shown in Fig. 2, p.163. From these, it is clear that the most effective arrangement is (F), even though (D) does give a higher peak. The reason for preferring (F) to (D) is because the curve is flatter, covering a greater area above the S9 datum-line than any other arrangement; thus, it is the most suitable for VFO operation, as it gives more latitude on tuning. Without the hat, even small changes of frequency would call for re-resonating the system. With the hat on, frequency changes of 15 kc or so *plus* to *minus* could be made without seriously affecting the radiating efficiency.

Indeed, it is clear that the effect of the capacity hat is always to flatten the curve by, so to speak, reducing the peak. In none of the tests would an aerial with a capacity hat give better peak signals than the same aerial without a hat.

### Effect of Base Section

While all these tests were proceeding, the conclusion was being reached that the base section of the whip—that is, the 4ft. length from the bumper mount to the bottom of the loading coil, which

it supported—was contributing nothing to radiating efficiency. This lower section seemed quite "dead to RF" in comparison with the "feel" of the system along the loading coil and in the whip section above it.

This was investigated by mounting the loading coil directly on the bumper bar, with results as shown in curves (E) and (G) in Fig. 2.

Since the S-meter readings in both Figs. 1 and 2 are directly comparable under all conditions, it is clear that the 4ft. section below the loading coil was contributing next to nothing in terms of radiation. And its elimination reduced the overall length from 11ft to 7ft., a factor of some importance from the mechanical point of view.

It was deduced that what drop there was in S-meter readings was probably due to the capacity of the car body on the loading coil and on the first few feet of the upper whip section, now brought down by the removal of the lower section. This assumption was thereupon tested by mounting the loading coil on the lower 4ft. section in the mechanical sense, but cutting it out of the system electrically—in other words, it was arranged simply as a support for the coil. This was done by feeding the loading coil by a 4ft. length of coaxial cable with the sheathing earthed to the car body; the layout was then somewhat as Fig. 3. The effect was to elevate the loading coil and top whip section to the original position, with the coil above the level of the car roof.

Earthing the 4ft. lower section, or joining the earthy sheathing at the top of the length of coax to the upper end of the support (points X, Y in Fig. 3) made no difference whatever to the S-meter readings on the local test. All the radiation was taking place

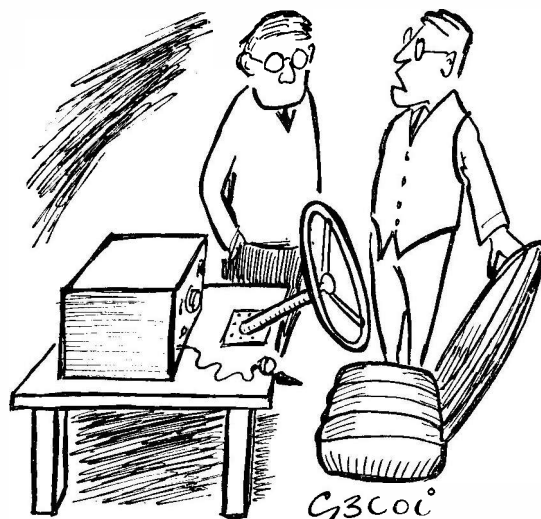

"... Oh, I don't drive nowadays but I do like the atmosphere of mobile..."

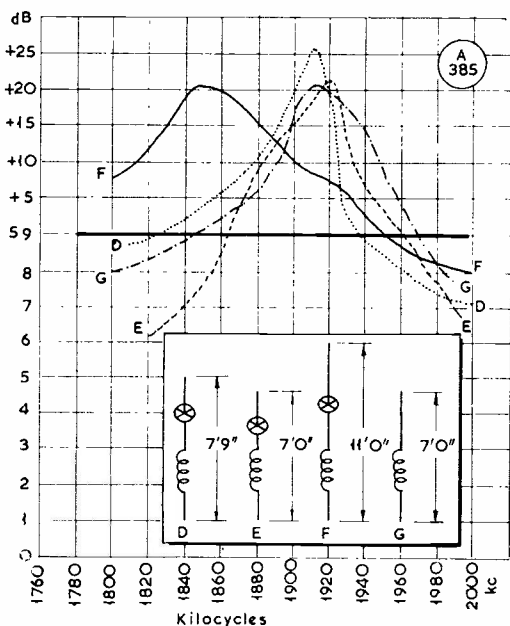

Fig. 2. Curves taken using a capacity hat—see discussion. This investigation suggests that configuration (F) is the best of the four, because the curve is flatter and thus gives more latitude for VFO operation. The effect of the capacity hat is always to lower the resonant frequency and its actual position above coil was found to have no significant effect on radiation.

off the upper section, and the lower part was quite dead to RF.

The result on a distant-site test was a 5 dB improvement over the best previously obtained, Condition (C) in Fig. 1. This small increase is consistent with the drop noticed by lowering the loading coil and upper whip section into the "shadow" of the car body, and supports the validity of the argument.

**Main Inference**

From the foregoing, it would appear that the best radiating system for mobile working on Top Band is a base-loaded whip, with an upper section of at least 6ft., fitted with a capacity hat about a foot above the coil, the whole mounted on the roof of the car.

If this is impracticable, then the bumper mounting or other support should be such as to push the loading coil above roof level, again with a capacity hat and a top section as long as practicable. The lower supporting section for the coil should be made dead to RF, by the method shown in Fig. 3.

**Other Considerations**

In most cases, the layout chosen will be dictated by aesthetic as much as by mechanical and electrical considerations. Nobody could pretend that a whip aerial with a loading coil and capacity hat is a pretty thing, no matter how it may be disguised. Of course, what to a radio man looks smart and efficient—a

neat coil, with a small hat, the whole well made and cellulosed to tone in with the car finish—can still appear as a positive eyesore to anyone not much interested in its purpose. "Good gracious me, man," says she-who-must-be-obeyed, "what is that awful Thing you've got stuck on the back?"!

An easily detachable roof-mounting—so that the aerial can be taken down and put up quickly for strictly /M excursions—is one solution and is not difficult to arrange on most types of car; the few holes required can easily be camouflaged, and in most cases sucker-mountings would be satisfactory.

**Results on the Road**

It could be misleading to quote ranges and signal strength, since so much depends upon immediate location—but what can be said is that S9+ signals can be relied upon up to about 20 miles. This is an S-meter figure on a receiver capable of producing comfortable speaker output with a carrier level down to S3, provided it is reasonably modulated.

Comparative tests against 160-metre fixed stations having large radiating systems with the full 10 watts input and taken as reference signals, show that with most observers the signal from the mobile rig with the 5-watt transmitter into the GP whip compares very favourably, in some directions being only a matter of a couple of S-points down.

For the preliminary adjustment of the loading coil, whatever its position in the system, it will be

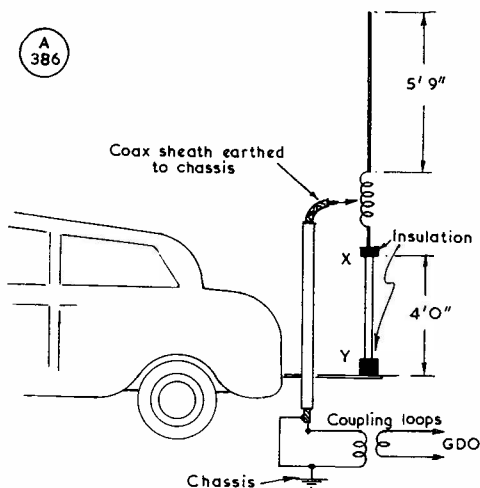

Fig. 3. The test set-up for the investigation, this also being to find out what the lower mounting section, beneath the loading coil, was contributing to the effective radiation. It was found that connecting or disconnecting the lower 4ft. section, or earthing the points X or Y, made no difference whatever—in other words, this lower length could be regarded simply as a mount to place the loading coil at the right height with respect to the roof of the car—see text. From the data in Fig. 2, which selects condition (F) as the best, the inference is that for VFO working with a swing of about 25 kc, a base-loaded whip with a capacity hat and upper section 6ft. long, the whole mounted on the roof of the vehicle (or with the coil above roof level) should give the best results under practical conditions. There is no electrical advantage in bumper mounting, though it is probably simpler mechanically than basing the whip assembly on the roof.

found necessary to provide a large number of taps. As an adjustment approaches the optimum, a *single turn* one way or the other will make all the difference in getting resonance at the desired frequency. But once the correct inductance value is found, it will hold over large variations in loading, as given by the *pi-coupler*. This is consistent with normal ground-plane behaviour.

The inductance value is so critical that it is not possible to "give it a name" in terms of so-many turns on such-and-such former with different whip lengths. It will always depend upon the length of the top section, the capacity of the GP element to the car, and the capacity of the car itself to ground. Obviously, this will not only vary with different makes of car, but also with the arrangement of the GP element with respect to the car. A whip length of so-many feet with a coil value of so-much may give the right result on one particular vehicle with the base connection at the rear bumper, but these values could be wildly out for another make with the aerial on the roof, or an old banger with the business lashed to a door handle.

In brief, what you have to do is to tune your system to your car, using the longest top section you can safely and conveniently manage.

Another vital factor is the proper weather-proofing of the loading coil—which, in the nature of things, is a very high-Q element. The coil as finally evolved must be absolutely impervious to weather effects. The slightest variation in Q-value will throw the coil right off.

There are, no doubt, many 160-metre mobile operators who have found out all this for themselves. On the other hand, it is also clear that many others are not getting the results that they had been led to expect—indeed, the wide variation in signal levels recorded on the occasion of any Mobile Rally suggest that many a /M aerial is not radiating as well as it might.

This article is not offered as expert opinion and advice, but rather as guidance on some of the practical problems associated with the design of mobile whip antennae for amateur use; in that respect, the data are not complete, in that there are several other possible arrangements that would be worth trying—such as a coil with a variable core adjustment; or variable transformer coupling, with the feed coil, linked to the transmitter, sliding over the resonating coil; or single-wire feed to a tap on the resonating coil, to give an auto-transformer effect. There are all sorts of possible variations.

However, it is hoped that, being based upon long hours of experiment under controlled conditions and giving repeatable results, the discussion here will be of interest to all engaged in getting going on Top Band mobile. Naturally, the findings are not thrown out simply as the outcome of a Saturday afternoon's work; in fact, the investigation alone absorbed something like 60 man-hours, to say nothing of the time taken in the preparation of the apparatus. And had it not been a partnership undertaking, by G3HMO and G6FO, it would probably not have been possible at all.

---

### GEORGE ROWLAND SCOTT-FARNIE, CBE, MIERE (G5FI)

It is with deep regret that we have to record the death, suddenly on Easter Sunday, March 26, of Rowley Scott-Farnie, G5FI, of Dolphin Square, London, S.W.1, in his 56th year.

He first came on the air in 1931, from Cefn Coed, near Merthyr, South Wales, as G5FI (this being before the GW prefixes had been instituted for amateur stations in South Wales). On leaving his Scottish public school he took banking examinations and entered Lloyds Bank, being appointed first to Ebbw Vale and then to Tredegar, in Monmouthshire. Most of his spare time was devoted to Amateur Radio, but he was also a keen rugger player and a good golfer. It was when playing rugger football for the local club that he sustained a leg injury which lamed him for life. He was one of the first to join the old Civilian Wireless Reserve, started in 1938 as an R.A.F. organisation for radio amateurs wishing to be prepared for the eventualities of war with Germany. He was commissioned (with the writer of this piece) into the Royal Air Force Volunteer Reserve early in 1939, and together they did their *ab initio* training at R.A.F. Abingdon in the summer of that year.

On the outbreak of hostilities in September 1939, P/O Scott-Farnie was posted to the Air Ministry for Signals Intelligence duties. He served with great

distinction for the duration and attained the rank of Group Captain, achieved by few officers of the V.R., Signals Branch. While in the Middle East he was severely burned and disfigured in an aircraft accident, and was one of the "guinea-pigs" restored by the famous plastic surgeon, the late Sir Archibald McIndoe. During his service with R.A.F. Intelligence, Rowley Scott-Farnie was specially successful in his dealings, first with the Russians, and later with the Americans when on the staff of the Air C-in-C for the invasion of Normandy.

Immediately after the war, G5FI re-activated his amateur licence (as most of us did who had got through it) and was taken on by E.M.I. as personal assistant to Sir Ernest Fisk, the then managing director, also being responsible for what was going to be E.M.I.'s department for the Amateur Radio market.

On the formation of International Aeradio, Ltd.—a consortium of firms in the aviation industry, functioning on a common-user basis to provide telecommunications services—he became IAL's first operations manager. By 1953, he was general manager, and by 1957 the managing director, being made deputy chairman of International Radio, Ltd. in 1965.

Under his management over the years, the operations of IAL were greatly extended, to include package-deals with foreign airlines for their radio, radar and telecommunications services; the design and prototyping of equipment; the installation of



The late Gp. Capt. G. R. Scott-Farnie, CBE, MIERE (G5FI), managing director and deputy chairman, International Aeradio, Ltd., Southall, Middlesex. 1911-1967.

full air traffic control systems; the training of controllers; and the publication of maps and charts for the use of international airlines. The firm now provides and operates aviation communication services on a world-wide basis. All these centres of IAL activity were regularly visited by its energetic and far-seeing managing director.

The scope of this work, for which he was made C.B.E. in 1959, brought Rowley Scott-Farnie into contact with the leading people in aviation all over the world and, outside his IAL responsibilities, he held a number of important official appointments connected with the industry.

But with it all, he maintained a close and practical interest in radio amateur operating, and from his flat in Dolphin Square was regularly on the DX/SSB bands whenever he was at home. (He was featured in our "Other Man's Station" series in the June, 1956, issue of *SHORT WAVE MAGAZINE*.) His career and achievements amount almost to the classic example of the keen radio amateur who, turning his knowledge and experience to practical account, became a successful professional in a highly competitive field. Being intended for a career in banking, it is certain that unless he had held an amateur licence and so had been engaged on signals duties at the highest levels in the R.A.F. during the war, he would never have moved into such spheres of activity after it.

Though an active AT-station operator in the London area, he was little known as a "local"

because he did not concern himself much with the social goings-on in the Amateur Radio context—like so many others, he was content to keep his personal contacts to those made on the annual occasion of the Amateur Radio Exhibition.

An intimate friend of the writer's since boyhood, he will also be missed by many other old friends of South Wales days—the first Welsh NFD station was set up in the field behind his parental home at Cefn Coed. His widow and his widowed mother will have the deep and sincere sympathy of all who knew Rowley Scott-Farnie, G5FI.

A.J.F.

---

### INTERESTING MARINE CONTRACT

Two new trawlers now building for Boston Deep-Sea Fisheries, Ltd. are to be fitted with a range of radar and radio communication equipment which only a few years ago would not have been found on many ocean-going ships of much greater size—showing how the state of the art has progressed even where catching fish is concerned.

Each of these ships is to have, as main Tx, a 1.2 kW CW/Phone transmitter capable of DSB/SSB working at long range; two fully transistorised communications receivers; a 90w. DSB telephony transmitter for short-haul traffic; an automatic watch Rx to monitor continuously on the 2182 kc R/T distress frequency; fully automatic D/F equipment; internal sound-reproducing and radio receiving apparatus for crew entertainment; and VHF R/T gear for inter-ship working and communication with the owners' private base stations at Hull, Grimsby and Fleetwood. The main Tx/Rx installation will enable the ships to work telephony back to base even when fishing off the Grand Banks, in Newfoundland waters.

The contract, which is being handled by Redifon, Ltd., Wandsworth, London, also includes the provision of radar for safety and navigation; fish-finding and echosounding gear; and a Decca Navigator set. Trawler skippers of even 20 years ago, accustomed to working by "smelling the wind," might be baffled by this lot—yet it is what is regarded nowadays as standard equipment for modern fishing craft, entailing the full-time attention of at least one radio officer. He also is trained and appointed under Redifon arrangements.

---

### THE R.E.C.M.F. EXHIBITION

This is probably the most important radio-electronics show of the year, staged by the British Radio & Electronic Component Manufacturers' Federation. It takes place at Olympia, London, during May 23-26—and it is certain that there will be many holders of AT-station licences to be seen there, either as visitors or officiating on the stands. As in previous years, all the leading firms—and many which have yet to make a name—will be represented, and there will be much to see and to discuss.

• • • SWL • • •

SHORT WAVE LISTENER  
FEATURE

ADVENT OF THE R.A.E.—TECHNICAL NOTES  
AND COMMENT—READERS' NEWS, VIEWS AND  
GOSSIP

By *Justin Cooper*

QUITE soon after this issue appears, the event of the year in the SWL world takes place, namely the R.A.E. At about 9.30 on the evening of May 12, several hundred people will be downhearted, and a few jubilant—emotions which in the writer's experience, seldom relate closely to the final results which appear some time later.

The paper usually asks the candidate to answer so many questions from the total—say, all the questions in Part I and any six from the eight shown in Part II. Now, if this instruction is followed, and an attempt is made at the right number of questions, even if he does not manage to finish them all, he has a vastly better chance of passing than the chap who “writes a book” on a few questions and leaves the exam-room without at least attempting the full number of questions called for.

The next few days could well be spent in practising the art of answering questions “against the clock” in a time of twenty minutes. The night before, a thorough check should be made that all the necessary equipment to be taken into the examination is to hand—watch, rubber, pencil, pen, sharpener, ruler, and so on—and that the pen is full enough to last out the evening or a refill is available. Most important of all is the bit of paper which gives entrance to the exam. room.

As to the R.A.E. itself: Technique, as already indicated, is all important in ensuring that the hard-won knowledge is displayed to the best advantage. Write tersely and clearly, and above all *legibly*. You may of course rest assured that your J.C. will have set aside a liberal supply of first-quality type-approved joss-sticks to be burned on your behalf—and at least one class knows he will be outside the room with a shotgun at the end to deal faithfully with anyone who has the thundering cheek to fail!

Notes and News

The letter from *Geoff Bowden (Crawley)* and son Philip always has something of interest, and this time is no exception; Geoff has been with us a year, and by the end of the season, if all goes well, should be leaving to join CDXN. For him, the R.A.E. course has cleared up a lot of misconceptions on matters technical, although, as he says, he expects to have lots more in the future. True enough, but if only amateurs—and professionals for that matter—would go back to the fundamentals whenever odd things need explaining, many of the misconceptions would never gain currency. In his other “hat” the writer is in the electronics industry, where he is blessed with a wise old gov'nor who after thirty-odd years is as up-to-date as 1968. This man says “If you

don't disprove Ohm's Law once a week you aren't earning your salary—but you'll never disprove Ohm's Law!” What he means is that one regularly jumps to conclusions that flout the laws of nature; but that when one reaches such a conclusion, a consideration of it against the *basic* principles such as Ohm's Law, will *always* reveal the flaw in the argument.

From *Leigh-on-Sea*, comes a letter from *R. T. Jackson*, who is interested in the /AM (aeronautical-mobile) signals sometimes to be heard on the bands. This is a question which would need a young book fully to answer—as to who, how, why and status over other countries' territory—but in brief, let us say there are very few of these stations about and they are all U.S. types.

Congratulations from us all to *R. de Buis (Felixstowe)*, on his recent marriage to a YL who does not mind the intrusions of Amateur Radio—lucky fellow! Add to that a new SR-600 receiver, a present from his wife (!), and it seems clear that Richard has a long and happy marriage ahead of him.

Up in *Goole*, *G. Cowling* is back in business with a new drive-cord on the CR-100, and seems to have been tasting the delights of 28 mc, which band has been going as well as it ever has in your J.C.'s memory, during the last few days.

A chap who answers his own questions is useful to have around, and *J. Hodgson (Gainsborough)* is just such a one; however, in this issue, the rules of the HPX Ladder are reprinted on p.170 just to make sure. He also refers to the stations in the M.A.R.S. (Military Associate Radio System) network; these are all just at the band-edges, and work only non-amateur stations or U.S. amateurs, to pass third-party personal message traffic (“Phone patch”), and hence are not countable. They are semi-official and quasi-military.

*John Tozer (Plymouth)* is not only in for the R.A.E., but also for his O.N.C. Mechanical—just about the best possible from the career point of view, as there are very few mechanical types around who have enough electrical knowledge really to be much help in the design of specialist electronic equipment.

Incidentally, there are many of our regular correspondents who mention they are in for examinations, and to all of them from all of us go our very best wishes for success.

A novel scheme proposed by *R. A. Gape (Leigh-on-Sea)* involves building a multiband converter, using only one crystal on various of its overtones. Many snags are inherent in such a scheme. The Butler oscillator proposed



is an "overtone" crystal oscillator, where the crystal is persuaded to oscillate at the "overtone" frequency; hence, the fundamental and lower-frequency harmonics, other than the selective overtone, are just not there, in contradistinction to the case of a "harmonic" oscillator where the rock is made to oscillate at its fundamental frequency and in the process churns out a lot of harmonics, the preferred one of which may be picked out with a tuned circuit. The snags in SWL Gape's proposal, are, as we said, pretty formidable, but there is no doubt it can be done—so it will be interesting to see the next batch of mail!

Quite another argument forms the theme of the letter from *Alan Grove (Bromley)* who is a little hot under the collar about the various stations, and in particular W's, who make a habit of conducting their local contacts on the DX bands. This is always a difficult one—what about the chap who is equipped with gear for one band only, and for some reason wants to have a contact with a local? Is he to be barred for the accident of his favourite band being full of DX?

And talking of DX, this month we have a letter which comes from *Singapore*, from *Jim Dunnnett*, who has managed to keep his entry in the Tables rolling in fine style.

Possibly the most pleasant thing connected with the column so far as your conductor is concerned is the act of welcoming a lost sheep back to the fold; and this goes for *J. F. Hobson (High Wycombe)*, who used to write from his old QTH at Emsworth in Hampshire. He has since lived in Australia, but the part of VK where he lived was so hot that the rival attractions of the fishing-rod and the swimming-pool overcame him—but a return to the U.K. and three weeks with a Drake 2C, have combined to produce his starter in the Table of 242.

The ground-plane aerial belonging to *D. Rollitt (Navenby)* is down again but it is an ill wind that blows no one any good—he finds that the 45° bend thus created has most magical properties in the way of producing new DX, due to the directivity accidentally created. And so—it remains bent for a while.

When all is said and done, much of the interest of

this hobby, like so many others, lies in the paperwork *E. Parker (Hove)* realises this and has Evolved a System, using about thirty sheets of foolscap, which provides an "instant check" on any prefix heard, so that there is now no chance of a new one being missed. There are also the memories which are evoked by looking over old logs; this aspect is well brought out by *T. W. Moss (Topsham)* who, in his 82nd year (*yes!*) can look back over his magnificent DX logs of many years, and compare the results over several sunspot cycles.

\* \* \*

The reception of SSB by those who are not lucky enough to have graduated past the BC set stage is quite a problem, which is mentioned by *A. Pyne (Budleigh Salterton)*. His solution is to bring up another BC receiver and arrange a coupling between the aerial of the receiver being used and the oscillator of the other one. This is achieved by putting an insulated wire in parallel with the aerial and arranged so that it lies around the mixer oscillator stage of the other, taking care of course to ensure no short-circuits, particularly if either of the beasts happen to be AC/DC. Having tuned the receiver to the signal desired, the other receiver is tuned across the appropriate range until SSB is resolved. It has to be borne in mind that the oscillator frequency of a receiver will be higher than the dial frequency by the IF. Hence, to resolve a SSB signal on, say, 14.2 mc by use of another receiver the IF of which is 465 kc (a typical figure) the outboard receiver should be tuned around a dial setting of 13.735 kc, when its oscillator will be running at 14.2 mc. This is the external-oscillator method of resolving SSB, and is quite effective.

\* \* \*

*Dennis Boniface (Ripon)*, perhaps best-known as an exponent of DX/TV, also spends a little time chalking up the prefixes while he monitors the TV bands for odd conditions which may mean an opening. This time Dennis sent in an interesting photograph of a Stockholm station sending its Test Card, unfortunately not good

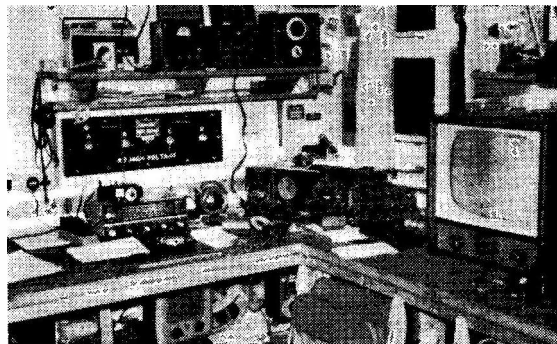
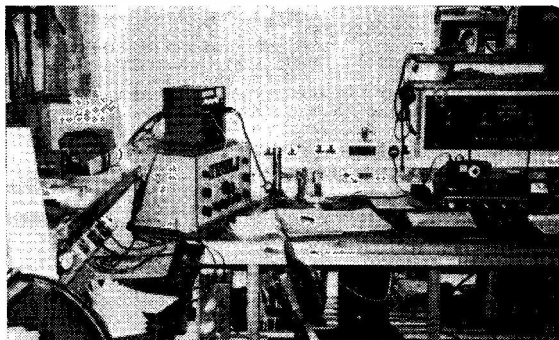

The SWL outfit installed and operated by R. E. H. Walker, 3 Bridge Hill, Stainforth, Doncaster, Yorks., is in a shack he designed and constructed himself to get the radio disturbance away from the family! Completed in October '66, this shack is of timber, 90 per cent fire-proofed by the use of special paint, and lined throughout with glass-wool and Selatex boarding, resulting in a heat-loss of less than 8 per cent. The gear, arranged on benches round three sides, consists of six receivers (from AR88LF to a PCR-3) and he also has a comprehensive selection of test gear, including a signal generator and two wavemeters. It is not surprising that SWL Walker has had many requests for details of his layout and the shack he has built for the gear.

enough to reproduce; and this month he has seen signals from East and West Germany, Holland, Yugoslavia and Italy. All-time DX/TV score is now 25 countries and a total of 132 different stations. Like many another busy chap, Dennis is always willing to help others wishing to start in on this activity, and the address to write to is *11 Holmefield Road, Ripon, Yorks.*

Photographs were also enclosed with the letter from *P. Cooper (Luton)*, who uses an HRO-5, with its power supply unit, speaker, and a Grundig TK-14; in eleven months of operation this set-up has netted a total of 101 countries, although as yet only fifteen have stumped up with the longed-for QSL.

*M. R. Warburton (Sale)* has a final entry on the Table, as he has now moved to Fordingbridge in Hampshire, and therefore starts all over again from the new place.

Your conductor's comments about the aerial and the ATU in recent months has sparked off a response from *S. Cusworth (Wakefield)*; Steve has both bought a pre-selector and built an ATU. As a result of comparative checks, he reckons the ATU has as much gain as the pre-selector and cost £7 less! This means that a whole new layer of DX becomes audible when the ATU is used. But, depending on the receiver, and it may be that there is some justification for using both.

First letters are often very interesting and the one from *D. L. Hill (Edinburgh)* is no exception. David uses an ex-Admiralty receiver of Murphy origin, the Murphy type-number being quoted as 100335, which we suspect is probably a serial number in fact. Naturally, if anyone has any ideas on this beast, David will be very pleased.

A dipole for each band from Forty down to Ten, and 270 feet of wire out for use on Top Band and Eighty, is quite a fair old aerial farm—such as that owned by *G. J. Smithies (Halifax)*, who uses three receivers, of which the favourite is an Eddystone 940.

The notes on pirates in these notes last time made *Stuart Swain (Hayling Island)* rather cross, insofar as he had managed to send most of the stations named QSL reports—hard luck indeed.

Having recently got around to designing and getting printed a batch of cards, *Stewart Foster (Lincoln)* naturally put a few into circulation, with considerably worth-while results, bringing his total to 251 countries confirmed out of a total of 270 heard.

Lincoln is also the home of *W. Felton*, who raises his HPX total to 669, thanks in the main to the recent activity on Ten, which has been to his advantage, as the legal types would say.

The quick note from *P. Coull (New Romney)* shows a formidable rise in the HPX ladder. He innocently asks what your poor old J.C. has scored in this line. A good question indeed, and one that cannot be answered without a little embarrassment! Having fairly recently moved QTH many of the old logs and notes have been destroyed, and in any case the interest has been along WPX rather than HPX lines!

The lure of DX/TV as inspired by Dennis Boniface has led *B. Stephenson (Ripon)* to dispose of his entire HF-band set-up in favour of DX/TV and Seventycem gear. This decision was triggered by the move into a large new shack which gives access to the roof-space, with room to erect as many separate antennae as may be

needed; however, Barrie is not quite lost to us as later on he intends to scratch together enough boodles to replace the old R.208.

In Dublin's fair city there lives EI7BK, who writes in to say that this is why he will not be signing plain *B. Cullen* in future. Our congratulations, and let us hope the new call is always a source of pleasure. Brian asked a question on the problem of local and DX working on Forty. In general it can be said that when the locals are off the air the DX will be heard, since Forty is never dead in the sense we mean in connection with, say, ten metres. Basically, this means that the time to try working DX is *not* in the early evening when the band is a foot-

## HPX LADDER

(Starting January 1, 1960)

Qualifying Score 200

SWL	PREFIXES	SWL	PREFIXES
PHONE ONLY		PHONE ONLY	
T. R. Popham (Exeter)	1012	Miss P. Longbone (Hull)	387
D. Douglas (Dundee)	972	D. Edwards (Coalville)	382
P. A. Cayless (Exeter)	953	E. Parker (Hove)	380
S. Foster (Lincoln)	827	T. Bailey (Burgess Hill)	378
A. W. Nielson (Glasgow)	803	E. K. Law (Walsall)	362
D. Rollitt (Navenby)	740	B. Stephenson (Walsall)	358
J. Singleton (Hull)	702	D. J. Mortimer (Gloucester)	358
A. Niblock (Ilkeston)	683	W. C. Torode	
C. Squires (Saltash)	677	(London, W.C.1)	350
P. Milloy (Doncaster)	669	D. Douglas (Dundee)	342
W. Felton (Lincoln)	669	A. P. Ashton (Stowmarket)	339
E. R. Chivers (Lydney)	658	A. Hydes (Enfield)	323
R. G. Preston (Norwich)	614	R. G. Glaister	
J. Tozer (Plymouth)	587	(Haywards Heath)	316
J. Hodgson (Gainsborough)	585	M. R. Warburton (Sale)	316
G. S. Taylor		(AM only)	
(Wolverhampton)	581	J. Miller (Cheltenham)	315
C. Edwards (Warwick)	556	P. Freeman (Chessington)	315
J. Fitzgerald		T. R. Popham (Exeter)	312
(Great Missenden)	553	(SSB only)	
P. Coull (New Romney)	549	B. Thomas (Castleford)	306
T. Pinch (Plymouth)	542	R. A. Gape (Leigh-on-Sea)	288
K. Southgate (Leigh-on-Sea)	520	P. Smith (Linby)	287
G. Bowden (Crawley)	518	J. Singleton (Hull)	282
A. G. Scott (Liverpool)	517	(AM only)	
W. Moncrieff (Hampton)	516	K. F. Ballinger (Worcester)	277
K. C. Staddon (Strood)	516	A. Grove (Bromley)	276
S. J. M. Blaber		D. L. Hill (Edinburgh)	273
(Haywards Heath)	516	C. K. Skelcher (Larkhill)	270
D. Fitzgerald (Dublin)	510	I. Patterson (Carstairs)	270
T. Wylie (Elderslie)	505	B. Walker (Doncaster)	270
B. Cullen (Dublin)	505	R. Young/P. Barrett	
N. Henbrey (Northiam)	502	(Welwyn)	269
J. Dutton (Ilkeston)	495	P. D. G. Milloy (Doncaster)	269
S. Swain (Hayling Island)	488	(AM only)	
P. Baxter (Winchester)	483	S. Cusworth (Wakefield)	266
P. A. Cayless (Exeter)	480	J. M. Dunnett (Singapore)	255
(AM only)		A. McCudden (Glasgow)	254
M. G. Allen (Heston)	470	T. Farkasch (Benfleet)	251
C. Claydon (Kinghorn)	466	A. Pyne (Budleigh Salterton)	251
D. H. Foster (Rainham)	460	A. Niblock (Ilkeston)	250
D. Bailey (Dagenham)	452	(AM only)	
J. W. Thompson (Tollerton)	441	J. F. Hobson	
J. Tring (Sutton)	436	(High Wycombe)	242
R. T. Jackson		R. Gilchrist (Manchester)	240
(Leigh-on-Sea)	435	D. Boniface (Ripon)	235
B. Macklin (Winchester)	435	M. G. Toms (Ilford)	227
G. Watson (Sheffield)	429		
G. J. Smithies (Halifax)	422		
J. Dixon			
(Barrow-in-Furness)	421	R. de Buis (Felixstowe)	487
S. Hardisty (Accrington)	421	B. A. Smith (Ruislip Manor)	386
A. P. Legg (Sutton)	412	R. Bacon (Thetford)	384
Mrs. M. Worby (Dartford)	406	J. M. Dunnett (Singapore)	368
A. Jones (Newport, Mon.)	405	P. A. Cayless (Exeter)	327
L. Case (Widnes)	404	T. Pinch (Plymouth)	309
H. M. Graham (Harefield)	391	S. Blaber (Haywards Heath)	307
D. C. White (Looe)	387	J. Miller (Cheltenham)	303
G. Cowling (Goole)	387	C. Harrington (Maidenhead)	283
		T. Wylie (Elderslie)	228

(NOTE: Listings only include recent claims. Failure to report for two consecutive issues of "SWL" will entail removal from the Table. Next list, July issue, for which the deadline will be June 2.)

Nice Rx set-up owned by Gus Coleman, 3 Knox Road, Clacton-on-Sea, Essex, who has an R.107 (centre) as his main receiver, flanked by an R.208, an R.1132A and also an R.109A. His aerial is a long-wire 50ft. high. What looks like some Tx gear is some Tx gear, for Gus has knocked off the R.A.E. and is getting ready for operations on the 70 cm. band. The map on the right-hand wall is our "DX Zone Map."



thick in EU's but rather in the early mornings or after midnight.

\* \* \*

L. Case (Widnes) has also written in to say that he is giving up HPX for the time being, because in his case it is a question of getting his nose to the grindstone and preparing thoroughly for the R.A.E. In the interim, construction is also proceeding so that the gear will be available, and also practice is in progress for the Morse test, with help from G3VTM. Incidentally, the construction project in hand is the "Mini-Five" Transmitter featured in SHORT WAVE MAGAZINE in November and December last year.

The liveliness of the 28 mc band is mentioned time and time again in the current crop of letters, and since the deadline it has been going just as hard, giving the newcomers a real taste of the best in the way of DX. One of those who commented on it was H. M. Graham (Harefield) who nevertheless has not missed much of the goings-on on the other bands.

\* \* \*

Top of the Ladder some years ago was A. W. Nielsen (Glasgow) who since then has been very busy with one thing and another so that several people have managed to overhaul his score. A thoughtful letter on many topics, and possibly the most cogent comment is that maybe the widespread use of SSB will have an effect in reducing the recruiting to Amateur Radio by way of the chance-heard QSO on a broadcast set, as nowadays such receivers will not make sense of a Phone contact.

Straight after these two old-timers we come to a

first letter from a thirteen-year-old, R. Gilchrist (Manchester) who has packed so many points into his epistle that we could take up nearly the whole piece discussing them. His birthday comes just early enough to make it worth his while to sit for the May R.A.E., for which he is receiving a lot of help from G3RHI. Robert is a trifle acid on the perpetual bleats from the characters who want a novice licence to save themselves the trouble of learning to be an amateur properly. Your J.C. is reminded of another letter mentioning a signal heard on the U.S. Citizens' Band saying "Eeny Meeny Miney Mo, anyone hear my radio?"—if this is the sort of thing we would get if a CB allocation was permitted in this country, we should be thankful the GPO is thinking the way it is!

Still on the subject of Novices, G3IDG (Basingstoke) writes in to clear up the situation as far as the U.S. allocation and conditions are concerned, much of which overlaps the note on p.104 in the April issue. However, Allan also mentions the question of QSL'ing these WN types. As he says, the majority of them do not realise their signals are audible at DX, and hence they are only too pleased to receive a card. The ploy here is to QSL direct—most of them give their full QTH—and not *via* the bureaux, as experience shows few returns this way, possibly because the intended recipient does not realise there could be cards for him at his bureau, and hence makes no arrangements to collect. All of them are on CW, but as their test speed is only 5 w.p.m. the vast majority of their contacts are quite easily deciphered. As for hearing them, they can be found whenever the 21 mc band, in particular, is open from the U.S., provided one tunes to the appropriate part of the band, 21.1-21.25 mc.

[over

### HAVE YOU GOT ONE?

We are always glad to see good photographs of SWL stations for possible reproduction in this feature. QTH and the necessary descriptive notes must be given on a separate sheet, not on the back of the print itself. We pay for any that can be used—but remember that the picture must be bright, sharp and clear to be suitable for publication. Send to: "SWL," Short Wave Magazine, Buckingham.

Iain Paterson (Carstairs Hospital) has a longer HPX list this time, and mentions specially the nice QSL and the accompanying letter from a YL operator, KIADY in Orrington, Maine, who gave him many useful tips and much know-how for which he is very grateful.

Listening at a set time can be a frustrating sort of process, but for A. G. Scott, his preferred time of 2200 to 0030 clock has been really FB of late, and has brought him up to 176 countries. The pile-ups are felt to be a boon to the SWL, as they often lead him to a rare one that would otherwise be missed.

D. H. Foster (Swansea) is quite pleased with his new QTH, and as a result has been putting in rather a lot of time listening on Top Band, on which he has managed W1HCH, W1BB/1, W1HGT, W2BVN, K3EKO, ZB2AP, and VO1FB, using a 160-foot wire the supports of which are only 12ft. high, and a counterpoise 200ft. long. Your J.C. is prepared to lay a small bet that the absence of the counterpoise would have removed those W signals! The earth (or counterpoise) part of the layout is by far the most important in any end-fed system, and the more the radials (or the better the counterpoise) the better the thing will work. The old

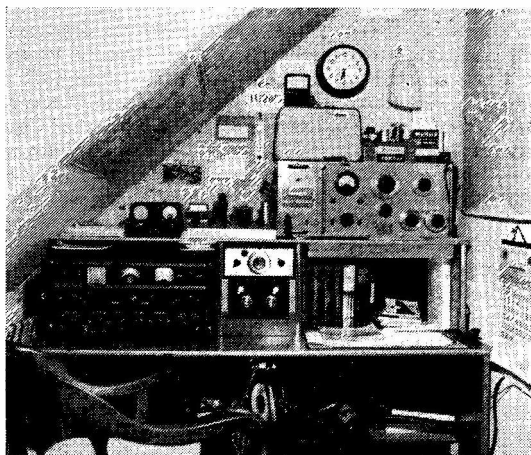

Main Rx item at the SWL station of E. & M. Bath (father and son), 54 Barrington Road, Southgate, Crawley, Sussex, is an AR88D (left), with which they have an ATU and a Codar preselector. Another item of equipment is a general-purpose monitor unit, built from the design by G3TDT in our September 1966 issue. They also have a signal generator, a 10w. amplifier, and a B.44 Mk. II modified for 4 metres. Aerials are an end-fed horizontal Vee, a Joystick VFA and a whip for VHF. Their shack is actually a converted coal cellar under the stairs, giving ample room for the gear and the two operators. They are both working for the R.A.E. and getting on with Morse.

method of simply driving an earth-stake into the ground is, in general, just not on when dealing with these systems, even though they may be half-wave, and at the shorter lengths as much as 90 per cent of the signal may be lost into the ground.

Reverting back to the subject of DX/TV, another reader expressing interest is B. Thomas (Castleford) who at the moment is chasing HPX on the LF bands only

### HPX RULES

- (1) The object is to hear and log as many *prefixes* as possible; a prefix can only count once for any list, whatever band it is heard on.
- (2) The /M and /MM suffixes create a new series; thus G3SWM, G3SWM/M and G3SWM/MM all count as prefixes and, where it is known to be legal, /AM also.
- (3) Where a suffix determines *location*, the *suffix* shall be the deciding factor, thus W1ZZZ/W4 counts as W4. Where the suffix has no number attached, *e.g.*, VE1AED/P/SU, VE2BUJ/P/SU, they are arbitrarily counted as SU1 and SU2 respectively, and the same holds good for similar callsigns.
- (4) When a prefix is changed, both the old and the new may be counted; thus, VQ4 and 5Z4 both count.
- (5) The object is to hear prefixes, not countries, thus there is no discrimination between, say, MP4B -- and MP4K --, which count as one prefix.
- (6) Only calls issued for Amateur Radio operation may be included. Undercover and pirate callsigns will not be credited, nor may MARS stations be claimed.
- (7) G2, G3, G4, etc., all score separately as do GW2, GW3, GW4, etc., and in the same way, K2, W2, WA2, WB2, WC2, WD2, WN2, all count even though they may be in the same street.
- (8) Send your HPX list, in alphabetical and numerical order, showing the total claimed score; with subsequent lists it is sufficient to quote the last claimed score, with the new list of prefixes, and the new claimed score, with your name and address on each sheet, to "SWL," SHORT WAVE MAGAZINE, BUCKINGHAM, to arrive *before* the SWL deadline for that particular month.
- (9) Failure to report for two consecutive listings, *i.e.*, four months, will result in deletion from the Table, although there is no objection to a "Nil" report—in order to hold your place.
- (10) **Starting score 200.** Phone Table is mixed AM/SSB but AM-only and SSB-only claims will be shown as such if requested. No mixed Phone/CW Table; the CW-only Table will be run separately.
- (11) Lists will be based on those shown in the current *Short Wave Magazine* List of Countries and Prefixes, as given on pp.561-566 of the November 1966 issue, and with the new edition of the *DX Zone Map*.

mainly due to awkward operating times.

Like father, like son—Michael Toms is a listener of one year's experience, and uses a CR-150 (no, not the Marconi one) in conjunction with a 20-metre dipole coupled with a tuned feeder for all bands. The reason for the comment is simple: This aerial was put up, in 1951, by Michael's father for just the same purpose!

Lots of queries this month from *Alan Hydes (Enfield)*, who mentions I2FRC; this one was an Exhibition Station of some sort, from Italy naturally enough.

*J. Singleton (Hull)* has been a trifle subdued of late, and seems to have been working too hard, but that has not stopped him from entering a healthy score into the HPX table this time. Just how short John is on time may be judged from his comment that he was typing his letter in his bath, and closed when the water went cold! And we believe him, too—there were some damp patches on the envelope!

Yet another entry for the Idiot-of-the-Year rating, this time from *C. K. Skelcher (Larkhill)*, who heard an EA plaintively calling a 3W8 no less than fifteen minutes after the 3W8 had announced he was going off the air.

Our late Top of the Form type, who has now started again, *D. Douglas (Dundee)*, threw us a bit more than somewhat when he wrote in this time and forgot to sign his epistle! Threw us, because there was a rather interesting snippet that we wanted to pass on to A. J. Devon, and as he is a stickler for names and things we had to do quite a lot of detective work in the attempt to establish who was who. So please, *everyone*, sign your letters, in block caps with full QTH even if you are an old-timer with us. Better still, sign as you always do with christian-name but *print* your full name and address on each sheet.

Several correspondents complain bitterly this time about the tendency of some stations to gabble call signs at the end of their overs; in particular, *J. R. Walker (Doncaster)* managed to lose a VK and a JA this way.

The usual gripe about Mittel-Europa call signs with T3 notes sending excessively fast Morse is repeated by *P. A. Cayless*, but Pete also says that there is a different side even to this coin—like the odd UA3, with a good fist and a signal to match. (Another very good operator is UT5CC, Kharkhov, and we don't say this simply because he happens to be a reader of this piece!)

\* \* \*

A really comic mix-up with cards sent to a French station *via* the Bureau is reported by *M. Goldman (Leeds)*, who ended up by getting a request from the F for a QSL, after he himself had initiated the exchange by

#### SWL's TO NOTE

The next appearance of "SWL" will be in our issue dated July, due out on June 30. All listener reports, HPX claims and pictures should reach us by Friday, June 2. Readers interested should note that, in general, it is not possible to take in reports received after the deadline—so please post in good time. The address is simply: "SWL," Short Wave Magazine, Buckingham.



Val Valentine, 48 Nutwell Lane, Armthorpe, Doncaster, Yorkshire, having been interested in Amateur Radio for some years, is going for his ticket at the next sitting. His Rx is an AR88LF, which has been thoroughly gone through, and he also runs a 19 Set receiver, modified for SSB. He has some good test gear and instruments as well, which will be very useful "when the time comes."

sending a report. Martin has an idea that his card was intercepted somewhere along the line, but your conductor suggests that a more likely explanation is that the F probably got his clerical work mixed up.

A couple of newcomers to "SWL": *R. F. Bence (Cardiff)* who has just completed a year on the air, during which he has progressed from an RX-60, through an 840C, to an AR88D. Using this, with an indoor Joystick, Ray has heard a total of around 1200 stations scattered through about 100 prefixes. The present objective is the R.A.E., with Morse practice. The other letter is from a couple of chaps who share a flat in *Welwyn*, *Peter Barrett* and *Bob Young*, and attend the local Technical College, their subjects being Physics and Electronics. As their courses are well organised the result is that both can find different times of the day to be on the air, although they share the gear. This consists of a Lafayette HE-40, and a Codar Preselector, used with an end-fed "piece of wire" about 45 feet long, at a height of 30 feet. Bob is taking the next R.A.E., and Peter the autumn one this year if plans go right, but of course this is somewhat dependent on progress with their professional studies.

To wind up, we have news of a retirement, namely that of *Terry Popham (Exeter)* who has done what he threatened to do and brought his HPX total up over the 1000 mark, 1012 to be precise. Congratulations to Terry, and a warning to all the others—he means to start again at the bottom and regain the top spot!

\* \* \*

With all the comments on This and That we have once again had to be a little selective in mentioning individuals and their letters. As far as possible, the space must always be used to deal with the points of general interest. Thus we acknowledge with thanks letters, and claims for the Table, from Norman Henbrey (Northiam);

Peter Baxter (Winchester); B. A. Smith (Ruislip Manor); A. P. Legg (Sutton, Surrey); Sapper Yarnold (BFPO 32); W. Moncrieff (Hampton); Chris Claydon (Kinghorn, Fife); T. Pinch (Plymouth); Colin Squires (Saltash); R. Glaister (Haywards Heath); J. Dutton (Ilkeston); K. Southgate (Leigh-on-Sea); P. D. G. Milloy (Doncaster); J. Tring (Sutton, Surrey); and D. Edwards (Coalville).

### Deadline

Reports and comments for the next piece, in the July issue, are as welcome as always and should arrive by first post **Friday, June 2**, addressed "SWL," SHORT WAVE MAGAZINE, BUCKINGHAM. Have a good Whitsun, and watch all bands.

## MOBILE RALLY PROGRAMME

With two events about to take place as this appears, and two more following shortly after, we hope to start publishing Rally reports and pictures next month, under the "Mobile Scene" heading.

Rally organisers are asked to ensure that we have a full report, with photographs, just as soon as possible after their event. With so many Rallies arranged for this season, it could happen that we have more material than we can use if early reports are delayed and start piling up with the more topical ones—and it is topicality that we are after, in the interests of all concerned. Any photographs we can print will, of course, be paid for and those sending in pictures are specially asked to include full details, with call signs given correctly, where applicable—all on a sheet separate from the photograph itself.

There are two additional events in this month's list—that for June 17, at the R.N. Air Station, Lee-on-Solent, Hants., looks particularly interesting. Several of the bigger Rallies also feature trade shows, when there will be much excellent commercial equipment on view.

**April 30:** North Midlands Mobile Rally, at Drayton Manor Park, near Fazeley, Tamworth, Staffs, half-a-mile off the A.5 at Fazeley. There will be excellent catering facilities, ample parking space and plenty for the family to do and see—there is a Zoo, for one thing, and there will be an exhibition and raffle. This Rally, one of the biggest of the season, is organised jointly by the Midland and Stoke-on-Trent Amateur Radio Societies. For further information apply: R. Palmer, G5PP, 22 Sherlock Road, Coventry (74070), Warks.

**April 30:** Medway A.R.T.S. Rally at British Uralite Works, Higham, near Rochester, Kent, with talk-in stations G2FJA/A 160m., G6CH/A 4m. and G3VFC/A 2m. on the air from 11 a.m. An interesting and eventful day is being planned for everybody. Further details from: P. Carey, G3UXH, 29 Miskin Road, Hoo, Rochester, Kent.

**May 6-7:** International Rally Week-end in Belgium, starting in Brussels at ON4UB on the Saturday, and taking in a meeting and lunch on the Sunday, with a dinner at the Red Cross Hq., Brussels, in the evening.

**May 7:** Thanet Radio Society Mobile Rally, at Cliff Top, Cliffsend, Ramsgate, Kent, with talk-in stations G3DOE 160m., G3JMB 70-56 mc and G3BAC 144-48 mc. Refreshments available on site, hotel and restaurant nearby, and magnificent sea views. For details, write: R. A. Bastow, G3BAC, 57 London Road, Ramsgate, Kent.

**May 7:** A.R.M.S. Picnic Rally and get-together at Burnham Beeches, Bucks. (off B.473, Slough-Beaconsfield). No programme, just a gathering of mobiles, and G3EJA/M will be standing by on 1910 kc from 2.30 p.m. for talk-in.

**May 21:** Northern Mobile Rally, organised by the Northern Amateur Radio Mobile Society, at Harewood Park, near Leeds, as in previous years. Reception from 12 noon, with all the usual attractions, including raffles and a grand surplus equipment sale. Refreshments available on site. Information from: D. Binns, G3MGI, 80 Gipton Woods Road, Leeds 8, Yorkshire.

**June 10-11:** Mobile meeting organised by the Section Manche, R.E.F., at Mont Saint-Michel, at which any U.K. amateurs who happen to be in the St. Malo-Granville district will be very welcome. There is a camping area suitable for caravans, and accommodation can be arranged through: Gerard Blin, F2NX, 52 rue St. Paul, Granville 50, Manche, France.

**June 11:** Mobile Rally at Mote House, Mote Park, Maidstone, Kent, organised by a radio amateur group in the Medway area, with G6NU as chairman of committee. Opening at 12 noon, talk-in stations will be on the air from 10.30 a.m. on 2-4-160m. Big raffle, trade exhibition, and a show of antique radio gear for collectors. Good refreshment facilities, family entertainment, side shows, ample parking space, and shelter for all if it rains. Profits will be in aid of the Home for Muscular Dystrophy. Further information from: W. E. Nutton, G6NU, 42 Richmond Road, Gillingham, Kent.

**June 17:** Royal Naval Air Day Rally at the R.N. Air Station, Lee-on-Solent, Hants., organised by the Royal Naval Amateur Radio Society. Opening at 12 noon, flying display 2.30 to 6.0 p.m., full programme with modern aircraft and hovercraft. Talk-in stations on Top Band and 70-26 mc for 4m. mobiles. Prizes, children's playground, refreshments. Details from: Hon. secretary, R.N. Amateur Radio Society, H.M.S. *Mercury*, Leydene, Petersfield, Hants.

**June 18:** Hunstanton (bucket-and-spade) Rally, organised by the local group. Talk-in by G3ANM/P on 1980 kc and G3PMH/P on 145-15 mc.

**June 18:** Amateur Radio Mobile Society annual Rally at R.A.F. (U.S.A.F.) Station, Alconbury, near Huntingdon, Huntingdonshire (*details later*). Advance information from F. J. Barns, G3AGP, 40 Park Ridings, London, N.8 (*for exhibition*), or N. A. S. Fitch, G3FPK, hon. secretary, A.R.M.S., 79 Murchison Road, Leyton, London, E.10 (*Tel. LEYtonstone 6700*).

**June 25:** West of England Mobile Rally, the 10th in the series, at Longleat House, near Warminster, Wilts.

- July 9:** South Shields Amateur Radio Club Mobile Rally, at South Shields.
- July 16:** Mobile Rally organised by the Worcester & District Amateur Radio Club, at Upton-on-Severn, Worcs.
- July 16:** Reading Amateur Radio Club Mobile Picnic at Childe Beale Trust Pavilion, Lower Basildon, Pangbourne, Berks.
- July 16:** Colchester Group Mobile Rally, to be held at Colchester Zoo. Talk-in on 2-4-160m. (*details later*).
- July 30:** Saltash & District Amateur Radio Club annual Mobile Rally, at Calstock, Cornwall.
- August 13:** Tenth Annual Mobile Rally organised by the Derby & District Amateur Radio Society, at Rykneld Schools, Derby (*details later*).
- September 3:** Swindon & District Amateur Radio Club Mobile Rally at Lydiard Park, Swindon, Wilts.
- September 15-17:** Third International Amateur Radio Convention and Rally at Knokke, Belgium.
- September 24:** Harlow & District Radio Society annual Mobile Rally.



Really keen chap, you might say! Roy Harrison, G3VPR, was married early in April at Market Deeping, Lincs. and had his copy of the April issue with him . . . "Soon be back on Top Band," said he, "QTH is 38 Park Avenue, Spalding, Lincolnshire."

#### JAMBOREE-ON-THE-AIR — SCOUT EVENT SUCCESS

The last (ninth) J.O.T.A. in October 1966 was the biggest and best-supported yet, in spite of an unfortunate clash with the CQ DX Contest, taking place over the same weekend. The break-down of the figures shows that the U.K. put on 194 amateur stations operated in the Scout interest, through which 127 different Scout stations were worked, in 27 countries. In all, 67 countries, from Algeria to Venezuela, had J.O.T.A. stations going. The 10th Jamboree-on-the-Air, to commemorate the Diamond Jubilee of Scouting, will take place over the weekend August 5-6, when it is hoped that once again AT-station operators will be able to entertain local Scout groups. (Contact you local Scout-master or District Commissioner.)

On this August occasion, there will be two exceptionally interesting stations active—K7WSJ at the 12th World Jamboree, Farragut State Park, Idaho, U.S.A., and GB3BSI, at the site of the original Scout Camp, held 60 years ago on Brownsea Island, Poole Harbour, Dorset. Nobody present on that occasion could possibly have imagined that within a life-time Scouts throughout the world would be linked by *Amateur* Radio.

#### MATTER OF A NAME

The rather ponderous "decision" that mHz should be used internationally for megacycles, with its derivatives, has not gone down with a swing everywhere—and, indeed, is being actively opposed in some quarters. It is quite wrong to assume, as has been stated, that "Continental countries have always called it the Hertz"—in fact, only the Germans (Hertz was a German) have

consistently used this term, and this they have done since the very beginnings of radio, even before the time of communication by wireless. (People like Oliver Lodge, Jackson and Branly used to speak of "Hertzian waves" but described them in terms of metres.) Hence, the Hertz is really no more than a Teutonic peculiarity, and could well have been left as such.

However, to be in the swim (and because we intend to stick to "kc" and "mc") we, too, must invent something (having already given such words as "sharsh" and "radionics" to the language), so it is proposed that henceforth Top Band should be known as the "Two Marconicycle Band"—and why not, pray? If Hertz's name is to be perpetuated, like those of Henry, Faraday, Ohm, Volta and Ampère (scientists after whom these electrical quantities were named), why not Marconi's, in the same sort of way, coming as it does so near to "mc" for megacycle? Any valid objection, even if the idea does seem revolting!

#### FINAL REMINDER—SSB DINNER

At the Royal Garden Hotel, Kensington, London, W.8, on Saturday, May 20. Trade show opens 3.30 p.m. Dinner at 7.0 p.m. Dancing, raffle prizes, cabaret and late-night refreshments till 1.0 a.m. Tickets for the evening, 75s. each; apply G3FPK, QTHR (or ring 01-539 6700). For hotel reservations, arrange direct, or ring 01-937 8000.

# THE MONTH WITH THE CLUBS

By "Club Secretary"

(Deadline for June Issue: May 5)

(Please address all reports for this feature to "Club Secretary," SHORT WAVE MAGAZINE, Buckingham.)

IN these preambles, your conductor has talked about various offices that have to be borne if a group is to make itself a success; of lectures and how to find them; of club stations and their influence; and of many other things. However, there is one element in the club which we have not discussed, and that is the most important one—the Ordinary Member, whose persistent presence (or absence!) at meetings and activities is the most reliable yardstick when attempting to measure the success or failure of any organisation of this sort.

Most committee-members would define the Ordinary Member as the chap who is always complaining, usually outside the clubroom, and *never* says a word at meetings convened for the purpose of altering the programme. He usually regards a meeting where business is discussed as a dead loss—he wishes to be kept fully informed of what is going on without this, and without having to read any sort of bit of paper on the notice-board—and any attempt at an interruption of the ragchewing, unless it be a good lecture on a subject he approves of, will result at once in suggestions that the committee is incapable of doing its job. If, as a result of his griping, he is nominated to the committee, he will demonstrate a previously unknown ability at the four-minute mile.

Not a very inspiring picture, and many committee-men get hot under the collar about it; but when all is said and done, it springs from the basic human nature. If any pushing is to be successful with the Ordinary Member it has to be skilfully disguised as leadership and served up on a plate. But why *should* the Ordinary Member be any different? After all, it is usually the chaps in the committee, whose minds are dreaming of the successes to come, who have a large interest in seeing the group flourish; and the Ordinary Member, to whom the meeting represents a night out with the boys, to be paid for by a couple of days in the doghouse, would not be very worried if the Club folded up altogether.

The moral seems to be that exhorting the members to do this and that, and chivvying them into group activities can be a waste of time, which could be better occupied in getting on with the job of running the Club, and of studying the members and their wishes as expressed over the air and at ragchews.

Reports this time have been divided up into heaps, on a broadly geographical basis, with a couple of smaller piles which cater for general-interest matters.

## Scotland

This is a large chunk of territory, from which we only see *regular* reports from two organisations, the **Radio Club of Scotland**, and the **Lothians** group. The latter had their first outside visit for several years recently, when they went to Turnhouse Airport Control Tower, and since then have had a very interesting and amusing talk on the U.S. Amateur Radio set-up, including the dreaded Citizens' Band, given by WØGNT. For the current events, refer to the secretary, which advice also holds good for the Radio Club of Scotland, who hold weekly meetings and also have a thriving section devoted to tape recording.

As a part-Scot, it grieves your conductor to say that these two, plus the "closed" Glasgow University Club, are the only ones in Scotland to have reported in the last year; there are known to be others, as is obvious when listening to MCC, or operating in NFD, but they never report. Thus, Justin Cooper, when he hears from a new chum who wants to get into a Club, can rarely help if the enquirer lives North of the Border, and much good new blood is lost to the hobby.

## New Group Proposed

We hear that the formation of a new group is suggested, to cover the area of **Bishops Stortford**, Herts; anyone interested, whether licensed or SWL, should send a note of his name and address to Andrew Marriott, G3VWC, at 21 Thorley Hill, Bishops Stortford (4796). If there is enough interest, a meeting will be called to inaugurate a new group.

## The South of England

This is by far the largest clip, with clubs contriving to exist happily within a few miles—or in some cases even yards—of each other. The first port of call is **Verulam**, who are to be found at the Cavalier Hill, Watford Road, St. Albans, on May 17, 7.30 for 8 p.m., when their own Brian Grist, G3GJX, will talk about "Modern Transmitter and Transceiver Design," and possibly demonstrate his KW-2000.

**Echelford** come next, by way of their *Newsletter*, which relates how one member took so much care over the prevention of unauthorised access to the equipment, in accordance with the terms of his licence, that he found himself, luckily during the local net, locked in the shack; and one of the other stations in the QSO had to ring his home to get him



released! On a more serious note we can say that the new Hq. at St. Martin's Court, off Woodthorpe Road, Ashford, Kent, is very popular; to try it turn up on Thursday, May 25, when the WIBB tape and slide lecture will be given. To cover the cost, a collection of not more than 6d. a head will be taken.

One of our most regular correspondents is the **Acton, Brentford & Chiswick** gang, who foregather on May 16 at 66 High Road, Chiswick, to hear G6RC talking about "Test Gear for Aerial Matching" to the members and the visitors who are, as always, welcomed.

Summer is the time for a good dose of fresh air, and **Purley** have taken this into account in settling the programme; hence May 5 is a natter-session and the 19th the lecture evening, with John Hobbs, G3JQN, giving the second part of his talk on VHF. Thus strengthened, the whole of the weekend May 20-21 is set aside for a full-scale dress rehearsal for field day, and so the operators contrive two successive weekends under canvas at Kenley Common—lucky chaps!

**Dorking** is the gang with the ex-GPO van, which is in constant use for one activity or another. The more static type of meeting occurs on May 9 and 23, both being Informals and both at the Wheatsheaf, Dorking.

Archery is not mentioned in these columns very often; but this month the **Paddington** crowd are joining up with the Aquarius Archery Club, Finchley, the scheme being to indoctrinate the radio types with archery, and the archers with radio. One can foresee the development of a self-homing arrow, guaranteed to hit the bull! Such an event is bound to cause a certain amount of cross-fertilisation, to the benefit of both sides. Normal sessions are held each Wednesday evening at 7.30, the venue being Beauchamp Lodge Settlement, 2 Warwick Crescent, London, W.2.

Twice monthly is the prescribed dose for the lads at **Chiltern**, who make use of the British Legion, St. Mary Street, as a meeting place; the 12th sees them with Bob Palmer, G5PP/M, the subject being,

of course, "Mobile Techniques," while the final briefing for field day is to occupy the whole of the evening of the 25th. Incidentally, it should be noted that the lecture is timed for a *sharp* 7 p.m. start, while the other meeting is at 8 p.m.

Last time out we mentioned the problems being encountered by the **Medway** lads and the fact that they were using the Conservative Club, Cuxton Road, Strood, as a temporary Hq.; this month it is pleasant to be able to report that they are to have the use of a room in the as-yet-uncompleted hall of a local Scout Troop; members are spending time in helping the boys put the finishing touches, and it is hoped that in a couple of months time their work will be rewarded by the first meeting at the new place. At the Conservative Club, the meeting on May 8 is a discussion night, while on the 22nd they are going out to visit the Signals Wing of the R.E. Barracks at Chattenden.

**Loughton** and District have recently held an AGM. It is clear that things are going to be made to hum in the next year, and a programme is being laid on with much enthusiasm. They are to be found at Loughton Hall, which is near the Debden station on the Central Line of London Transport, on May 5 and 19, and thereafter every other week.

A similar mood of optimism is apparent in the current copy of the **AERE (Harwell)** Club newsletter, and they hope to see far greater attendances in the future. The meeting on May 16 stars Dud Charman, G6CJ, and his now famous lecture on Aerials—and if for *this* lecture they can't fill the Social Club, AERE, Harwell, to bursting-point with members and visitors (who will be welcomed) they ought to be shot!

Once a fortnight on Thursdays the Congregational Church Hall, adjacent to the Clock Tower, Bexleyheath, is full of **North Kent** members—and there is usually something to interest them by way of a lecture or whatever; the second and the fourth are the Thursdays they meet.

Since the **Swindon** lads moved into their new

At a recent meeting of the Wolverhampton Amateur Radio Society, G6GR was demonstrating the basic principles of direction finding.



Hq. they seem to be getting together on alternate Wednesdays, the last firm date we have being now past, namely April 19, when the G3JO Cup competition was run off.

The future seemed to be in the melting-pot for the **Crystal Palace** group, as the local council are to demolish the Civil Defence Training Centre where they normally meet. However, alternative arrangements have been made—the C.D. Depot in Wood-yates Road, S.E.12—so it is suggested that anyone thinking of attending, on the third Saturday in each month, should check with the hon. sec. at the address in the panel. Next meeting is on May 20, when G6HD will initiate a discussion on modulation.

Having by now got the AGM out of the way, the **Surrey** crowd will be using the May meeting to deal with the Construction Contest; this will occur on May 16. Looking further forward, the July session is in the hands of G2UJ, who will talk about the Oscar satellites, and show some slides.

**Worthing** are to meet on May 9 to finalise all the details for their field day station, while the June meeting is given over to a talk by G6KFH/T on "Simple Printed Circuits for the Experimenter," on the 13th.

At **Farnborough**, the gang gather in the Model Railway Enthusiasts Club, 310 Farnborough Road, Farnborough. Unfortunately, while the hon. sec. mentioned that the May session was given over to G2AHY to talk about "Receiving and Transmitting Techniques," he completely forgot to tell us the date! However, a call to the address in the Panel should enable things to be sorted out.

G3FRB will address the **Cray Valley** crowd on May 4, on SSB Equipment. On the 18th, they have an informal. The venue for the former is the Congregational Church Hall, Court Road, London, S.E.9, while the informal will take place at the All Saints' Church Hall, Bercta Road. For those who attend meetings by way of public transport, the spot to aim for is New Eltham Library, or New Eltham station.

Now to **Reigate**, who, on May 10, will converge on the George and Dragon at Redhill for a discussion on Operating, Tactics and Planning in a Contest. The funds have recently received quite a boost from the Jumble Sale—but someone is a little cross, and with good reason—he had to rope in all his friends and relations to do the work, because the Ordinary Members just did not help. Seems they would prefer a higher annual sub. to a little—very little—work!

**Wimbledon** have a newsletter, entitled *QRK-5* which often has something interesting to say. Meeting dates are given for several months in advance, and from the list we understand that the programme for May 5 is to be decided, while for May 26 they have a talk on Amateur Television, which will be given by David Hughes of the British Amateur Television Club.

Five meetings, no less, are the constituents of the May programme of the **Maidstone YMCA** Radio Society. This little lot is made up from the following: on May 3 they learn all about "Professional Style

Chassis-bashing" under G3REM, while on the 10th they are to check out the Club Top Band Transmitter by putting it on the air. The 17th is set aside for a tape lecture, and on the 24th a talk by G3ORH on "Tower and Quad Construction" will make many folk start thinking about improving their own sky-wires. The month is rounded off by a final session at which all the loose ends will be tied up so that their field day effort goes without a hitch.

**Reading**, on the other hand, have only two dates fixed this month, and neither of them have any firm programme title—but we are sure something of interest will happen at St. Paul's Hall, Whitley Wood, on May 9 and 23.

The next stop is Welwyn Garden City, where the **Mid-Herts** Club holds sway; they will be at Welwyn Civic Centre on May 11 to hear and take part in a "Transistor Symposium" while two days later the Club will put GB3WGC on the HF bands so as to show the flag at the Welwyn Show, which this year is called "Contact '67." They will be alongside the beat groups, the model railway chaps, and the record society, but no doubt they will end up with a few more members!

Just up the road from Mid-Herts is the **Stevenage** A.R.C., who are to hear the W1BB tape lecture on May 4, and on the 18th have a lecture on Pilotless Aircraft Control. Both these affairs are to take place at Hawker Siddeley Dynamics, Gunnels Wood Road, Stevenage, the start being at 8 p.m.

We have heard it said that there is no activity in the **Haywards Heath** area—but we feel the members of the **Mid-Sussex** group would dispute this most strongly! The venue is Lindfield Primary School, near Haywards Heath, and the dates the 3rd and 17th. The former is set aside for a discussion of the Club's four-metre project, and also the question of their participation in the Burgess Hill Town Day. The informal on the latter date is not entirely without a programme, and it is suggested that if details are required the hon. sec. should be consulted.

No lack of novelty in the **Chelmsford** group's recent history—at one meeting they heard in stony silence an appeal for a pen-friend for a Russian YL! On a more serious tack, the next meeting is on the subject of "Propagation above 30 mc," to be given by Peter Blair, G3LTF, well known for his success on VHF; the date for this one is May 2, the venue Marconi College, Arbour Lane, Chelmsford, starting at 7.30 p.m.

Various things have been, and are going to, happen at **Harlow**, where the locals foregather every Tuesday and Thursday at the Mark Hall Barn, First Avenue. At very short notice, Fred, GM3SVK, on leave from Unst up in Shetland, gave a lecture, illustrated with tape-recordings, of his activities as the most northerly GM amateur station, and during the ensuing month there is a visit laid on "to a place of interest locally." On May 30 colleague G3KFE of CDXN will be talking about the operating of short aerials—which should keep the customers away fairly effectively! (Well, you said it!—*Editor*.)

**Southgate** report having picked up some new call signs as a result of the December R.A.E., and from their *Newsletter* we get it that at their next meeting, in May (no date given), the talk will be about the Port of London Authority.

**Maidenhead** will be running a Junk Sale on May 1 (for which *anything and everybody* will be welcome), and on May 16 the evening will be informal, meaning a general natter and get-together. Having already fixed Club visits to Cambridge and Heathrow, they now have another scheduled for the Racial Works at Bracknell, on June 17.

Fortnightly on Mondays, with the next on May 8 and 22, is the pattern for the meetings of the **Edgware** group—they also run a Club net every Wednesday at 2100 (presumably BST), on 1875 kc.

The Radio Society of **Harrow** has a solid weekly programme booked from May 5 to June 23 and, by the look of it, mainly of a practical nature. Harrow initiated the idea of Club Constructional Projects—see *SHORT WAVE MAGAZINE*, July, 1965—which has

been taken up enthusiastically and successfully by many other clubs. They also run a useful and interesting monthly called *QZZ*, compiled by G3JVM.

A monthly newsletter called *QUA* reaches us regularly, covering the activities of the **Wessex A.R.S.**, which also takes in the Royal Navy A.R.S. and the Southampton group. There are meetings at the Lancaster Building, Southampton University, and on Wednesdays and Fridays at 20 Carlton Road, Southampton, 7.0 p.m.

#### Wales and the West

This is, like Scotland, an area sparse in reports, but nevertheless we seem to get news of various clubs. The first one is **Chester**, who are to run a *DX*-pedition again this year, this time to *Orkney*, signing GM3GIZ/P during July 9-14, with operation mainly on Top Band—this should be an interesting trip. As for the rest of the programme, May 9 sees a Sale of Surplus, while the 16th is the date for a talk by Basil O'Brien, G2AMV. A lecture by G3OWY is

#### Names and Addresses of Club Secretaries reporting in this issue:

ACTON, BRENTFORD & CHISWICK: W. G. Dyer, G3GEH, 188 Gunnersbury Avenue, Acton, London, W.3.  
 A.E.R.E. (HARWELL): V. J. Galpin, Building 347.3, A.E.R.E., Harwell, Didcot, Berks.  
 A.R.M.S.: N. A. S. Fitch, G3FPK, 79 Murchison Road, London, E.10. (*Leytonstone 6700*).  
 BLACKPOOL & FYLDE: J. Boulter, G3OCX, 175 West Drive, Cleveleys, Blackpool.  
 CHELMSFORD: P. Chadwick, G3RZP, 121 Lady Lane, Chelmsford.  
 CHESTER: P. Holland, G3TZO, 19 Kingsley Road, Gt. Boughton, Chester.  
 CHILTERN: J. W. Burnham, G3UJK, 304 Desborough Avenue, High Wycombe, Bucks.  
 CORNISH: W. J. Gilbert, 7 Poltair Road, Penrhyn, Cornwall.  
 COVENTRY: R. Steptoe, 21 Wooton Street, Bedworth, Coventry.  
 CRAY VALLEY: D. Buckley, G3VLX, 234 Halfway Street, Sidcup, Kent. (*Tel. ELT 6945*).  
 CRYSTAL PALACE: G. M. C. Stone, G3FZL, 10 Liphook Crescent, London, S.E.23. (*FOrest Hill 6940*).  
 DORKING: N. Blackmore, G8ARH, 39 Dorking Road, Gt. Bookham, Surrey.  
 EAST WORCS.: J. Bazly, G3HCT, Brooklands, Ullenhall, Solihull, Warks. (*Henley-in-Arden 2176*).  
 ECHELDFORD: D. Walmsley, G3HZL, 153 Worple Road, Isleworth, Middx. (*POPeSgrove 3239*).  
 EDGWARE: G. S. Fitton, G3RAA, 18 Beverley Drive, Edgware, Middlesex.  
 EX-G RADIO CLUB: F. W. Fletcher, G2FUX, 53 St. Ives Park, Ringwood, Hants.  
 FARNBOROUGH: D. G. Arigho, G3NVM, 6 Frensham Close, Yateley, Camberley, Surrey.  
 FYLINGDALES: P. H. Ellis, 26 Westbourne Road, Whitby, Yorkshire.  
 HARLOW: R. Brown, G3TOF, 177 Radburn Close, Harlow (2357), Essex.  
 HARROW: R. C. Ray, G2TA, Wintons End, Springfield, Bushey Heath (1762), Herts.  
 HONG KONG: N. W. Willis, VS6FS, c/o Shell Co. of Hong Kong, P.O. Box 22, Hong Kong.  
 HULL: D. J. Peacock, G3NOP, 336 Cottingham Road, Hull.  
 LOTHIANS: A. J. Masson, GM3PSP, 20 Merchiston Park, Edinburgh, 10.  
 LOUGHTON: J. M. Stuart, G3TUM, 10 Stewards Close, Epping, Essex.  
 MAIDENHEAD: E. C. Palmer, G3FVC, 37 Headington Road, Maidenhead (20107), Berks.  
 MAIDSTONE: C. Robertson, G3ERY, 17 Northumberland Road, Maidstone, Kent.  
 MANSFIELD: F. N. F. Bewley, G8HX, 116 Westfield Lane, Mansfield, Notts.  
 MEDWAY: P. Carey, G3UXH, 29 Miskin Road, Hoo, Rochester, Kent.  
 MID-HERTS: H. R. Thornton, G3PKV, 43 Fordwich, Welwyn Garden City.  
 MID-SUSSEX: E. J. Letts, G3RXJ, 87 Meadow Lane, Burgess Hill, Sussex.

MID-WARWICKSHIRE: *Secretary's name and address wanted.*  
 NORTHERN HEIGHTS: A. Robinson, G3MDW, Candy Cabin, Ogdan, Halifax (64329).  
 NORTH KENT: P. T. Baber, 64 Latham Road, Bexleyheath (8655), Kent.  
 PADDINGTON: N. G. Copperwaite, G8AQO, 62a St. Marys Mansions, St. Marys Terrace, Paddington, London, W.2.  
 PORT TALBOT: H. G. Hughes, GW4GC, 20 Austin Avenue, Porthcawl, Glam.  
 PURLEY: A. Frost, G3FTQ, 62 Gonville Road, Thornton Heath, Surrey, *CR4-6DB*.  
 RADIO CLUB OF SCOTLAND: A. Barnes, GM3LTB, 7 South Park Terrace, Glasgow (041-339-4080).  
 R.A.I.B.C.: Mrs. Woolley, G3LWY, 331 Wigan Lane, Wigan, Lancs.  
 READING: G. A. A. Gale, G8APH, 1 Willwynne Close, Caversham, Reading (77423), Berks.  
 REIGATE: D. Thom, G3NKS, 12 Willow Road, Redhill, Surrey, (*Reigate 45033*).  
 RHYL: A. Antley, GW3UTG, Fairholme, Fairfield Avenue, Rhyll (1362), North Wales.  
 SCUNTHORPE: H. Holmes, G3MSB, 69 Crosby Avenue, Scunthorpe, Lincs.  
 SOUTH BIRMINGHAM: A. Bishop, 40 Cecil Road, Birmingham, 29.  
 SOUTHGATE: A. Dutton, G3TIE, 77 South Lodge Drive, Southgate, London, N.14 (*LABurnum 3390*).  
 SOUTH SHIELDS: D. Forster, G3KZZ, 41 Marlborough Street, South Shields.  
 STEVENAGE: D. R. French, G3TIK, 98 Austen Paths, Stevenage, Herts.  
 STOCKPORT: G. R. Phillips, G3FYE, 6 Ross Avenue, Davenport, Stockport, Cheshire.  
 STOURBRIDGE: R. A. G. MacIntosh, 50 Field Lane, Oldswinford, Stourbridge, Worcs.  
 STRATFORD-ON-AVON: I. A. Cobbold, G3RPF, 5 Avenue Road, Stratford-on-Avon (0789-2167).  
 SURREY: R. Morrison, G3KGA, 33 Sefton Road, Croydon *CRO-7HS*, Surrey (*ADDiscombe 5982*).  
 SWINDON: D. Goacher, G3LLZ, 51 Norman Road, Gorse Hill, Swindon (21740).  
 VERULAM: J. Thomas, G3RXA, 9 Highland Drive, Hemel Hempstead (55136), Herts.  
 WAKEFIELD: E. Price, G3TQV, 23 Elm Road, Horbury, Wakefield.  
 WESSEX: P. Cutler, 43 Langside Avenue, Wallisdowne, Poole, Dorset.  
 WIMBLEDON: K. Alexander, 23 Pepys Road, West Wimbledon, London, S.W.20.  
 WOLVERHAMPTON: J. P. H. Burden, 28 Coalway Road, Wolverhampton.  
 WORTHING: S. G. Williams, 79 South Street, Lancing (5371), Sussex.  
 YEOVIL: D. L. McLean, G3NOF, 9 Cedar Grove, Yeovil, Somerset.

slated for the 23rd, and the month is rounded off by a field day session on 30th.

Rhyl have recently held a Junk Sale, to which the members of the Conway Valley crowd were invited, and also have heard a lecture on "Transistor Receivers," by GW3JGA. For further details and the current list of activities, contact the Hon. Sec., GW3UTG, as in the panel.

"Open House" was the theme at **Port Talbot** on April 4, when the locals entertained about 50 visitors, from as far as Merthyr Tydfil, Pembroke, the Rhondda, Carmarthen, Barry, Cardiff, Swansea, and Swansea University clubs. With the visitors travelling such distances, a buffet was organised, and it was a most successful occasion. The next get-together for Port Talbot is slated for May 2, at Trefelen Workmen's Institute, Jersey Street, Porthcawl, and visitors are extremely welcome.

Somerset is represented by **Yeovil**, who are to be found every Wednesday evening at the Youth Centre, Park Lodge, The Park, Yeovil; current activities include a film show of the "Ship-to-Shore Radio" and "Beyond All Frontiers" titles, which will be given on May 10, and there is much discussion about and preparation for field day activities. Last time out we mentioned the sad accident affecting **Cornish**—this is probably why we do not seem to have any up-to-date news of the group, but only a report on the annual dinner on March 17, when about 60 members and guests were present. The proceedings included the presentation of a "lighthouse lamp" to G5AAC/W9WPV, who is off to Vietnam in June, and a slide show by G3UCQ, who visited Socorra with a Forces Expedition. For details of the varied activities of the Cornish club and its

sub-sections, we suggest contact with the temporary deputy for the Hon. Sec., address as in the panel.

### The Midlands

A Rather Difficult Area to define, this, so if any Club is offended by being either entered in this district, or transferred to some other one—our apologies!

**Scunthorpe** write in to mention that on May 29 (that is, the Bank Holiday Monday) they will be holding a Direction Finding Contest. All the details on this, and indeed of the club programme, are to be had by the usual simple process of getting in touch with the Hon. Sec.

*Newsletter Number 20* is the current epistle from **Stratford**, from which we learn that someone has boned the lens from their film projector; quite apart from the bad feeling that can arise from such an anti-social action, the programme may be in jeopardy, as the evening of May 25 is set aside for a film show. Earlier in the month, on the 11th, they plan for field day and on the 21st carry out a dummy run to "prove" the plans—but we still bet *somebody* will forget *something!* Incidentally, at the bottom of our copy of their newsletter someone has written in large letters "Open House on the dates mentioned, at Hall's Croft, Old Town, Stratford-on-Avon." So now you know!

It is surprising how rarely we hear of an Hon. Sec. laying down his office in the middle of his term, but this has happened at **Coventry**, because the recent bearer of the office is moving away from the district. New hon. secretary as in panel. For the members, May 5 is to be a film show, while on the 12th the club KW-2000 will be in use; the 19th is reserved for a local visit, albeit this is still "provisional." On the 26th, G3ROD takes the stand, and his theme will be "Designing Simple Transistor Circuits."

Another provisional date has now become firm, and that is for the **Wolverhampton** annual dinner, which will be at the Black Horse on May 15. It will be preceded, on May 1, by a session at Neachells Cottage, Stockwell Road, Tettenhall, at which the Home-built Gear contest will be played off.

Just about the northern limit of the Midlands brings one to **Mansfield**, where the New Inn, Westgate, contains lots of radio amateurs and SWL's on the first and third Friday of each month. The former is regarded as the main event, while the third-Friday session is given over to the noggin-and-natter type of meeting.

**Stourbridge** have recently moved to a new Hq. and are now at Longlands School, Brook Street, Stourbridge; the next date is May 2, when field day arrangements will be discussed; what time is left will be filled by G8GF, talking about "Ethics and Operating."

If anyone fancies himself as an editorial compiler all he has to do is join the **South Birmingham** lads—who need a new editor for *QSP*—at their Hq., which is the Scout Hut, Pershore Road, Selly Park, Birmingham, on May 17. He will then be able to commence his duties by giving a full report on the

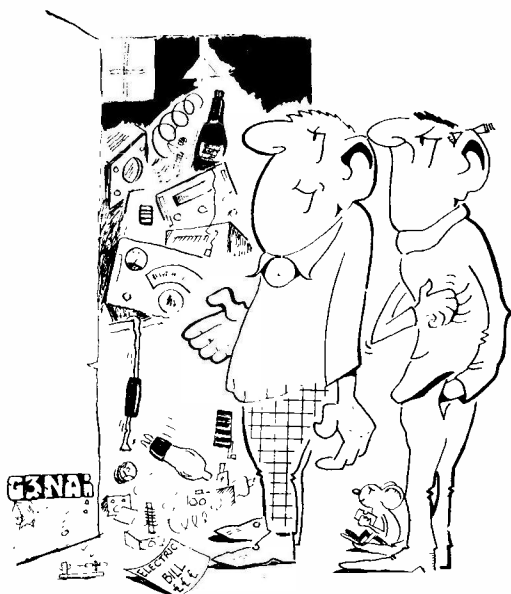

"... It's about time I squared the shack up a bit ..."



At the Cornish Amateur Radio Club annual dinner, in Truro on March 17, G5AAC/W9WPV received a gift (a lighthouse lamp) from the Club, presented by G3XC, left. Above, G3XC, president of C.A.R.C., with G3OCB (left) a well-known contributor to "Short Wave Magazine." This was another very successful occasion for a live and active organisation down in the far south-west.

Junk Sale, at which we are told articles worth pounds change hands for a few pence.

By way of the **Mid-Warwickshire QUA** we are sorry to hear that Ken Young, their secretary, has had to resign due to pressure of work, and hence we need a new name for the panel. For details of the Club, we therefore suggest reference to G3LZN (*QTHR*) the president.

Highlights of the **East Worcestershire** monthly programme include, for May, a discussion on field day workings and a junk sale (the first in years, and therefore advertised as "good"), and in June a talk by G3HZD on operating in Nigeria, on the second Thursday each month at the Old People's Centre, Park Road, Redditch, 7.30 for 8.0 p.m.

#### North of England

Under this heading we have reports from several very active groups. **Blackpool and Fylde RS** do not often report, but we see that they held their AGM a month or so ago, and hence inform us of the hon. sec.'s *QTH*.

Really an important topic, but one which rarely seems to crop up in programme lists, is the question of Safety in the Shack, and of course its natural companion First Aid. **South Shields** have this on the list, and on May 12 G2BCY will discuss the problem. This does not mean that the South Shields crowd are only in session once a month—far from it. Any Friday evening will find them at the Trinity House Social Centre, Laygate, South Shields. Extra-mural activities this summer are to include the Mobile Rally, fixed for July 9, and the South Shields Flower Show during August 11-13.

The Hq. of the **Hull** group is 592 Hessle Road, Hull, where on May 5 they will be preparing for field day, and on the 12th the hon. sec. will be answering questions for the benefit of the local R.A.E. students; on the 19th there is a Quiz, to which we gather other local groups have been invited; and on the 26th they have an evening on the Workshop Project.

G3MDW, the hon. sec. of the **Northern Heights A.R.S.**, is quite determined that we are going to have adequate notice of their meetings, and so he sends us full details of the June programme. June 7 is set aside for the annual visit to Manchester Radio Club—which is looked forward to with eagerness on both sides—followed by the Halifax Gala on the 10th, and on the 21st by an informal. The "home" meetings are held at the Sportsman Inn, Ogden, Halifax.

Blossoms Hotel, **Stockport**, is a nice name for the Hq. of a blossoming group, who have recently had talks on such diverse subjects as SSB, Trans-

#### IMPORTANT!

Reports for this feature must reach us by the due date—see head of article every month—and include the full *QTH* and telephone number (if available) of the honorary secretary, for the Secretaries' Panel. Scribes who undertake regular reporting are asked particularly to watch these points. Reports for "Month with The Clubs" should be addressed: Club Secretary, Short Wave Magazine, Buckingham.

mission Lines (by G3NUQ), Aerials, by G2JT, Atomic Energy, and a talk by a BEA Trident pilot. No wonder they are thriving. New members are, of course, very welcome, and for details a line to G3FYE at the address in the Panel is the recommended procedure.

Up in **Fylingdales**, near Bridlington, East Yorkshire, the AGM produced a committee of five members, with G3VGN in the chair. Among other things, it was decided that the Club should again put on an exhibition station, for the Whitby Regatta, August 19-21. We wish them luck with this year's effort.

#### And the Others

Here we note the activities of those groups who cannot conveniently be placed in the other categories—such as, for instance, the **Ex-G Radio Club**, which caters for "Radio Amateurs born in the U.K. and Domiciled Abroad" is it describes them on the title-page of the *Ex-G Bulletin*. While the membership is, naturally enough, composed of W/VE types in the main, there is a strong minority who seem to manage to pop up just about anywhere in the world you can think of. As a result it is the *Bulletin* that keeps them all together, and a very good job it is doing.

Another one that undoubtedly is looked forward to every month by its readers is *Radial*, which is the monthly publication of **RAIBC**. Most months we contrive to rub home the need for support here, and this time we give prominence to a rather different aspect, namely the balance-sheet, published in the March issue. From this we glean a rather interesting fact, and that is that the figure "Grants to Mem-

bers" is almost exactly balanced in the other column labelled "Donations," at a figure a little above two hundred pounds. Grants to members is a phrase that covers a multitude of factors—from getting an invalid amateur a rig modified for his disability to simple comforts—and if the donations don't roll in, the comforts can't roll out. Quite a lot of groups put aside so-much per cent of the receipts of some function of theirs, such as a Mobile Rally, to be given to RAIBC—but how about every Club in the country offering 10 per cent of the Junk Sale profit?

On to the **Amateur Radio Mobile Society**; this month their *Mobile News* carries an article by G3BID on the subject of "Defence of the Amateur Bands." Additionally, there is a (reprint) article on the Radar Speed Trap—PETA—which explains how the thing works, and the order of magnitude of possible errors.

The *Newsletter* of the **Hong Kong A.R.T.S.** dated February has just reached us, and discusses a familiar topic—the painful matter of finance. A large sub-increase seems inevitable, what with costs up by four times since 1947, when the present subscription was last fixed, and many new commitments. Among a number of other matters of interest to H.A.R.T.S. members there is the first part of an article (by the late VS6AE) showing that it was as long ago as 1923 that radio amateur activity first began to stir in the exotic Colony of Hong Kong. Incidentally, the VS6 boys run a regular Sunday net on 14200 kc, from 1730z.

And that seems to about wrap things up for this time; 73 and good luck till next time round, for which the deadline must be **Friday, May 5**, addressed, as usual, to: "Club Secretary," **SHORT WAVE MAGAZINE, BUCKINGHAM.**

#### SPECIALLY ON THE AIR

Clubs or local groups organising an amateur-band station to appear and perform in public, or in support of some public occasion, are invited to send in details for this space, set out in the form shown here. For special events of this nature, the GPO will usually issue an appropriate for-duration-only call sign.

**GB3WGC, May 13:** Organised by the Mid-Herts. Amateur Radio Society for the Welwyn Garden City "Convention of Town Activities," operating on 10-15-20m. QTH for QSL's and enquiries: H. R. Thornton, G3PKV, 43 Fordwich Road, Welwyn Garden City, Herts.

**GB3BWC, May 20-21:** Operated by the Marconi Apprentice Association Radio Club in connection with the Cub's Camp at Thriftwood, Essex. All bands 160m. to 15m., CW/SSB, and two-metre AM, will be worked. Skeds with any Scout station or group are specially requested. Write: P. E. Chadwick, G3RZP, c/o Education Office, Marconi House, New Street, Chelmsford, Essex.

**GB3CSR, May 20-21:** Put on by the local group for the East Cheshire Scouts Diamond Jubilee Rally, Devisdale Park, Altrincham, working all bands 160m.

to 4 metres, mainly SSB. Several thousand Scouts and visitors are expected, and the Chief Scout will be present. For information and QSL's: S. J. Scarborough, G3MBQ, 95 Cavendish Road, Hazel Grove, Stockport, Cheshire.

**GB3RED, May 29:** For the Redbourn Annual Fair, on Redbourn Common, Herts. (off the A.5), arranged by the local group at the special request of the Redbourn Association. Bands worked are to be 160m., AM/CW, and CW/SSB on HF. Skeds will be welcomed, and a special QSL card is being printed. Arrangements with: L. S. Duffy, G3TXP, 60 Snatchup, Redbourn (493), St. Albans, Herts.

**GB3SBF, June 5-10:** In conjunction with the Scarborough Benelux Festival Week, from the North Bay promenade, running 10-80m. with a KW-2000, CW/SSB. For further details, skeds and QSL's: R. E. Barker, G3KEE, 12 Pinewood Drive, Woodland Park, Scarborough, Yorkshire.

**GB3IIF, June 21-30:** Arranged by the Isle of Wight Radio Society for the Island Industries Fair, Ryde Airport, I.o.W., operating on all bands, AM/SSB, including two metres, and using beams for HF/VHF. Hon. secretary I.o.W. R. S.: M. A. Cooley, 13 Hazely Coombe, Arreton, Newport, Isle of Wight.

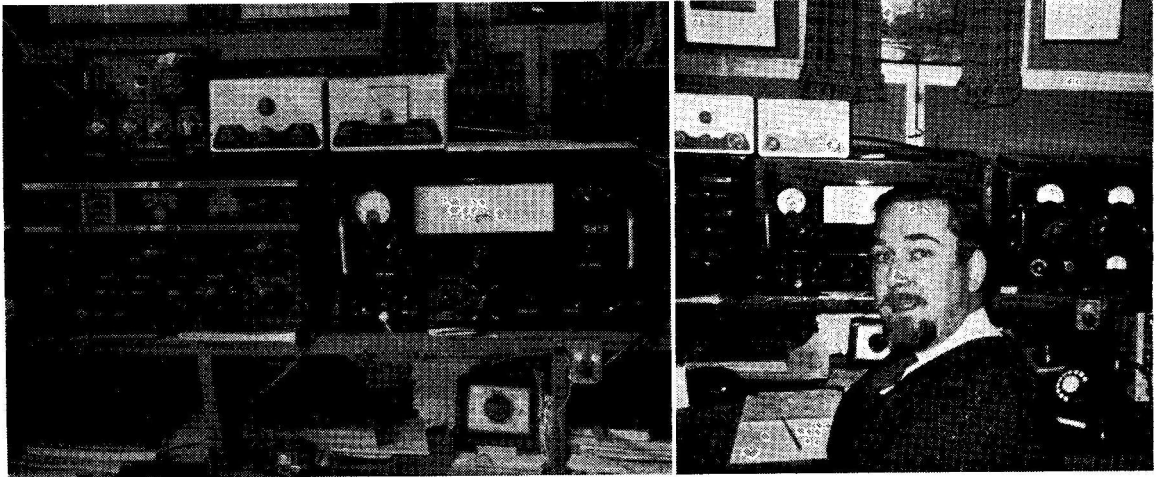

## THE OTHER MAN'S STATION

**9H1R**

OUR subject this time is an ex-R.N. type who, on leaving the Royal Navy in 1947, has been settled in Malta since then—Ronald Meachen, 9H1R (ex-ZB1RM), 1 Jasmine Path, Santa Lucia, Malta, whose job in life is instructing in radio at the Technical College out there.

As all who are regularly on the air will know, 9H1R is very active on all bands, running a CW/SSB rig with a linear amplifier giving up to 600 watts p.e.p. His Rx is an AR88D modified for Sideband and having a Q-multiplier as an outboard unit. CW is achieved by a home-built keyer, and other equipment includes a Heathkit SWR bridge.

The aerial system at 9H1R consists of a three-element tri-band beam, somewhat similar to the Mosley TA-33 but home-constructed, controlled through a CDR

rotator; also available is an 8KW trap-dipole, much used on 40m. and 80m. The shack is a hardboard, asbestos-roofed erection in the garden, with just about enough space to accommodate everything.

Anyone wishing to raise Malta or 9H1R will find the local (Malta Amateur Radio Society) net in action on 3600 kc SSB every Sunday morning at 0900z, changing to 21.15 mc at 1000z (any mode available) for the express purpose of attracting G's, who are invited to break in.

Many amateurs who visit Malta on holiday or business call in on 9H1R and are always welcome to operate his rig. He will be glad to discuss visit possibilities by QSO and is a very good signal in the U.K. And, by the way, Malta is in Zone 15 and scores 3 points for us—not much, but worth having!

### OCEAN RACING — RADIOTELEPHONE

#### WARNING

Owners of vessels entering for the forthcoming Ocean Power Boat Races in American waters are warned by the Post Office that they may be risking disqualification by failing to comply with the rules of entry and licensing requirements concerning ships' radiotelephones. Some competitors are fitting out in preparation for Atlantic crossings unaware that the specific radiotelephone equipment required by the rules has to be specially licensed in this country.

Safety requirements call for a properly installed radio transmitter-receiver, with a minimum of 25 watts output, on 2182, 2738 or 2670 kc, and one American local frequency; but competitors whose

vessels already have otherwise suitable radiotelephones may not know that, apart from 2182 kc, their existing *licences* do not cover installations working on these frequencies. To establish a ship station of the type required, the owner or operator must hold the Post Office Restricted Radiotelephone Certificate or a higher qualification. It is important that the licensing and operator's certificate requirements are met before leaving the United Kingdom to ensure compliance with the rules of entry. Intending competitors in the Nassau and other international events are therefore advised to apply for details of how to obtain the Restricted Radiotelephone Certificate and for permission to install on the necessary local frequencies. Information can be obtained from: The Inspector of Wireless Telegraphy, Radio Services Department, G.P.O., Union House, St. Martin's-le-Grand, London, E.C.1.

# NEW QTH's

This space is available for the publication of the addresses of all holders of new U.K. call signs, as issued, or changes of address of transmitters already licensed. All addresses published here are reprinted in the U.K. section of the "RADIO AMATEUR CALL BOOK" in preparation. QTH's are inserted as they are received. up to the limit of the space allowance each month. Please write clearly and address on a separate slip to QTH Section.

- DL5XX**, D. A. C. Jack (*G3OFV*, ex-*E13AH* / *ZC5DJ* / *9M6AJ* / *9V1ML*), c/o Sgts' Mess, 2 Div. Hq. & Signal Regt., BFPO22.
- E13BL**, M. Barrett, 25 Morrison Terrace, Ballina, Co. Mayo.
- G3URA**, R. G. Whittering, Arnocks, High Street, Herstmonceux, Hailsham, Sussex. (Tel. *Herstmonceux 3273*.)
- G3VMU**, C. J. Davis, 12 Thrift Street, Wollaston, Wellingborough, Northants.
- G3VTT**, C. L. Turner, 11 Bader Way, Rainham, Essex.
- G3VUO**, J. Mills, Woodlands, Downham Road, Downham, Billericay, Essex.
- G3VXX**, J. Lester, 173 Damson Lane, Solihull, Warks. (Tel. *Solihull 3060*.)
- G3VYF**, M. Lee, 37 Middle Lane, Crouch End, Hornsey, London, N.8.
- G3VYP**, K. C. Muller, 423 Chester Road, Castle Bromwich, Birmingham. (Tel. *CAS 2358*.)
- G3VZI**, Amateur Radio Society, Staffordshire College of Technology, Beaconside, Stafford.
- G3VZS**, H. J. Green, 89 Blenheim Road, North Harrow, Middlesex. (Tel. *Harrow 5673*.)
- G3VZU**, W. Mooney, 538 Liverpool Road, Great Sankey, Warrington, Lancs.
- G3WBG**, H. J. R. Hindle, 57 Woodside Way, Shinfield, Reading, Berks.
- GM3WCF**, P. Dudelis, 8 Kier Hardie Terrace, Dunfermline, Fife.
- G3WCK**, R. H. Godley, 87 Clifden Road, Clapton, London, E.5.
- G3WCM**, F. Chidlow, 64 Mitchell Avenue, Northside, Workington, Cumberland.
- G3WCW**, S. M. Marcus, 259 Hale Lane, Edgware, Middlesex. (Tel. *01-958-7608*.)
- G3WDB**, R. W. Salvidge, 9 Tudor Court North, Wembley, Middlesex. (Tel. *WEM 8425*.)
- G3WDI**, T. F. Weatherley, 34 Landrock Road, Hornsey, London, N.8.
- G3WDO**, F. W. Hill, 20 Sunnymead Road, Roehampton, London, S.W.15. (Tel. *01-876-6575*.)
- G3WDY**, D. Pike, 27 Cintra Park, Upper Norwood, London, S.E.19. (Tel. *LIVingstone 4738*.)
- G3WEB**, G. W. Gardiner, 11 Langdale Avenue, Ramsgate, Kent. (Tel. *Thanet 51164*.)
- GM3WEE**, C. W. Davidson, o/b/o Amateur Radio Society, Heriot-Watt University, Chambers Street, Edinburgh.
- G3WEF**, A. L. Beazley, 24 Tealsbrook, Covingham Park, Swindon, Wilts.
- G3WEG**, P. M. J. Webster, 8 Kinlet Road, Shooters Hill, London, Shooters Hill, London, S.E.18.
- G3WEK**, W. E. King, 20 Welland Avenue, Grimsby, Lincs.
- G3WER**, L. C. Hearn, 16 Vine Close, Welwyn Garden City, Herts. (Tel. *Welwyn Garden City 26694*.)
- G3WET**, J. G. Evans, 17 Heathfield Road, Four Oaks, Sutton Coldfield, Warks. (Tel. *Four Oaks 2951*.)
- G3WEV**, R. D. H. Hooper, 8 Pitchcombe Gardens, Coombe Dingle, Bristol.
- G3WFC**, M. E. Allard, 57 Priests Lane, Brentwood, Essex. (Tel. *Brentwood 1653*.)
- G3WFE**, A. R. Boyce, 26 Lancaster Avenue, West Norwood, London, S.E.27.
- G3WFS**, D. Foster, 23 Norwood Place, Leeds 6, Yorkshire. (Tel. *Leeds 56135*.)
- GW5ZL**, M. S. Garley, 46 Cherry Grove, Sketty, Swansea, Glam. (*re-issue*.)
- G6ACV/T**, M. N. Scarlett, 22 Old Mill Lane, Forest Town, Mansfield, Notts. (Tel. *Mansfield 27696*.)
- G8AXF**, J. Hopton, 330 Wetmore Road, Burton-on-Trent, Staffs.
- G8AXI**, M. N. Scarlett, 22 Old Mill Lane, Forest Town, Mansfield, Notts. (Tel. *Mansfield 27696*.)
- G8AXQ**, G. D. Avis, 30 Townley Way, Earls Barton, Northampton. (Tel. *Earls Barton 553*.)
- G8AXT**, C. S. Town, 43 Coleridge Road, West Melton, Rotherham, Yorkshire.
- G8AXU**, P. G. Murchie, 17 Kingswell Road, Arnold, Nottingham. (Tel. *Nottingham 264306*.)
- G8AXX**, S. Barker, 7 Step Row, Burnley Road, Bacup, Rossendale, Lancs.

## CHANGE OF ADDRESS

- G2HKA**, A. Grundy, 101 Wigan Road, Euxton, Chorley, Lancs.
- G2LD**, H. F. M. Baker, Stonestyle Cottage, Warren Street Road, Charing, Kent.
- G3ASM**, S. E. Hincks, 2 Downholme Grove, Hartburn, Stockton-on-Tees, Co. Durham.
- G3EGN**, W. E. Benson, 148 Wakefield Road, Lepton, Huddersfield, Yorkshire.
- G3FNM**, W. R. Parkinson, 141 Norris Road, Sale, Cheshire.
- G3JEJ**, W. B. Hartog, Cotton, Top Road, Little Cawthorpe, Louth, Lincs.
- G3KFE**, E. P. Essery, A.I.E.R.E., 17 Ascot Close, Parsonage Lane, Bishops Stortford, Herts. (Tel. *Bishop Stortford 2501*.)
- G3KML**, R. Whitfield, 42 Greenwood, Tweedmouth, Berwick-on-Tweed, Northumberland.
- G3LTZ**, M. Allenden, 10 Carshalton Road, Park South, Swindon, Wilts. (Tel. *Swindon 27450*.)
- G3NEP**, P. Bradley, 1 Pine Garth, Darras Hall, Ponteland, Newcastle-upon-Tyne.
- GM3NOU**, W. S. Dunning, 11 Mains of Kirkhill, Dyce, Aberdeenshire.
- G3NWQ**, M. J. Caplan (ex-*9VIMK* / *9V1RS*), 14th Signal Regt., Robinswood Barracks, Gloucester.
- G3ONE**, E. L. Groom, 8 St. Margarets Road, Chelmsford, Essex.
- G3UGK**, P. R. Cragg, 115-A Courtlands Drive, Watford, Herts.
- G3VPT**, P. Burgess, 40 Julian Road, Spixworth, Norwich, Norfolk.
- GW6FW**, A. B. Wright, 42 Park Avenue, Hawarden, Flintshire.
- G8KW**, R. G. Shears, B.E.M., A.I.E.R.E., (*VE3BUS/VE3KWE*), 3 Windmill Park, Wrotham Heath, Sevenoaks, Kent. (Tel. *Borough Green 3637*.)



**LAFAYETTE RECEIVERS**  
FINEST VALUE FOR MONEY AVAILABLE TODAY



**MODEL HA-350**

Ham bands 10-80 metres, mechanical filter, 12 valves, double conversion, outstanding performance, 75 gns.

**MODEL HA-500**

Ham bands 6-80 metres, 10 valves, dual conversion, two mechanical filters, product detector, crystal calibrator. Only 42 gns. Carr. 10/-.



**MODEL HA-700**

General coverage receiver. 150-400 Kc/s., 550 Kc/s.-30 Mc/s., two mechanical filters, product detector, B.F.O., S meter, noise limiter, etc. Only 36 gns. Carr. 10/-.

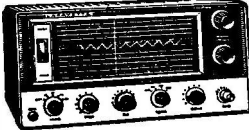

**MODEL KT-340**

General coverage receiver in semi-kit form. Few hours of work to complete. Full instructions, save pounds, 550 Kc/s.-30 Mc/s., 25 gns. Carr. 10/-.

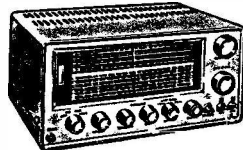

**MODEL HA-43A**

General coverage receiver. 550 Kc/s.-31 Mc/s. Incorporates RF stage, S meter, B.F.O., noise limiter, bandspread tuning, 7 valves plus rectifier, 24 gns. Carr. 10/-.

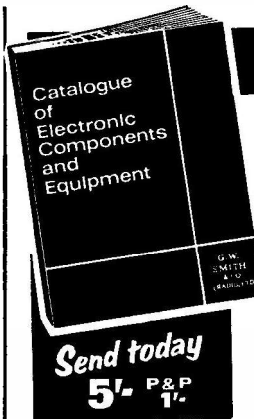
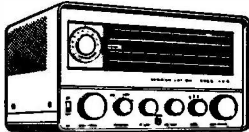

**CATALOGUE**

- ★ ELECTRONIC COMPONENTS
- ★ TEST EQUIPMENT
- ★ COMMUNICATION EQUIPMENT
- ★ HI-FI EQUIPMENT

We are proud to introduce our first comprehensive catalogue of Electronic Components and equipment. Over 150 pages, fully illustrated, listing thousands of items many at bargain prices. Free discount coupons with every catalogue. Everyone in electronics should have a copy, 5/- P. & P. 1/-.

Send today  
5/- P&P 1/-

**LAFAYETTE V.H.F. RECEIVERS**

**HA-55A.** 108-136 Mc/s. A.M. Aircraft receiver, £19/7/6. Carr. 10/-.  
**HA-52A.** 152-174 Mc/s. F.M. receiver, £20. Carr. 10/-.

**SURPLUS RECEIVERS**

**R.107.** 1.7-17.5 Mc/s., £15.  
**R.209 Mk. II.** 1-20 Mc/s., £15.  
**AR-88** receivers from £30.

**Hammarlund SP-600JX.** Few only of these outstanding receivers. 540 Kc/s.-54 Mc/s. Cost over £500. Available in excellent condition, £100.

**HAM-1 COMMUNICATION RECEIVER**

Five valve superhet receiver, covering 550 Kc/s.-30 Mc/s. S meter, B.F.O., built-in speaker, bandspread tuning, 16 gns. P. & P. 10/-.

**AGENTS FOR**

- ★ T. W. ELECTRONICS
- ★ CODAR
- ★ CONTACTOR SWITCHGEAR
- ★ PARTRIDGE AERIALS
- ★ ELECTRONIQUES
- ★ SOMMERKAMP
- ★ **AR-88D.** 455 Kc/s. crystals. New and boxed, 15/- P. & P. 1/-.

OPEN  
9 a.m.-6 p.m.  
EVERY DAY  
MON. to SAT.

**G. W. SMITH & CO. (RADIO) LTD.**

3-34 LISLE STREET, LONDON, W.C.2

Phone: GERRARD 8204/9155

PART  
EXCHANGES  
WELCOME

**MARCONI INSTRUMENTS LIMITED**

ST. ALBANS · HERTFORDSHIRE

**ARE YOU A SKILLED AND EXPERIENCED ELECTRONICS TECHNICIAN ?  
HAVE YOU BEEN A WIRELESS OR RADAR FITTER IN THE ARMED FORCES ?  
CAN YOU DO A PROFESSIONAL REPAIR JOB ON A T.V.?  
DO YOU HAVE GOOD TECHNICAL QUALIFICATIONS BUT LACK INDUSTRIAL EXPERIENCE ?**

If you can answer " YES " to at least one of these questions then we should like to hear from you.

We need now test and calibration engineers to help us increase the output of our very wide range of telecommunications measuring instruments.

The work requires the understanding of the most modern and varied circuit techniques and embraces all frequencies up to u.h.f.

The posts are permanent and pensionable; they offer first class staff conditions in a key export Company of English Electric; they will prove attractive to men who believe strongly that there is a real career for them in production.

Applicants should apply in writing, stating age and experience, to the:—

Personnel Officer, Marconi Instruments Ltd., c/o Directorate of Personnel (SM.2890.D.), English Electric House, Strand, London, W.C.2.

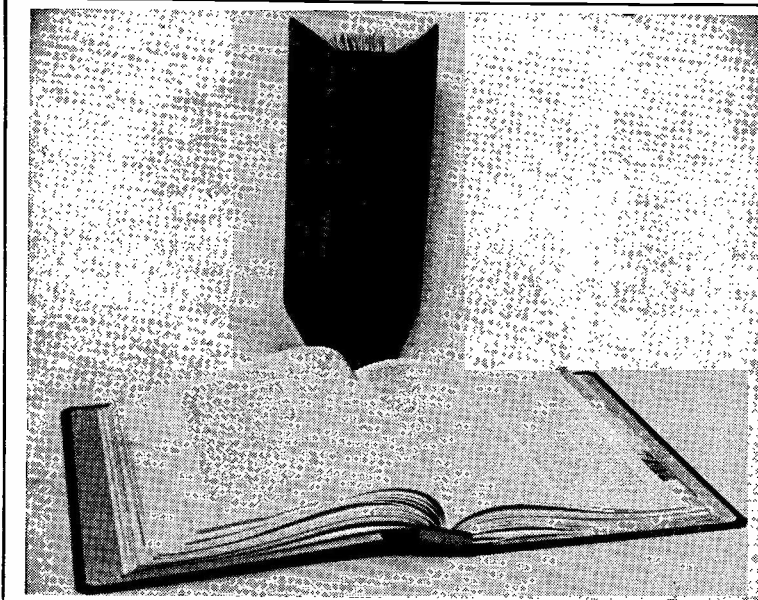

## CREATE YOUR OWN REFERENCE LIBRARY

by binding copies of Short Wave Magazine in the "EASIBINDER."

The "EASIBINDER" is designed to bind 12 copies of the Magazine as you receive them month by month, eventually providing a handsomely bound volume for the bookshelf.

No need to wait until twelve copies are assembled. As each copy is received, it is quickly and simply inserted into the binder. Whether partially or completely filled, the binder is equally effective, giving the appearance of a book, with each page opening flat.

Strongly made with stiff covers and attractively bound in maroon Leathercloth and Milskin, the binders have only the title gold blocked on the spine.

Price 14s. 0d. post free.

PUBLICATIONS DEPARTMENT  
SHORT WAVE MAGAZINE  
55 VICTORIA STREET  
LONDON, S.W.1

## SMALL ADVERTISEMENTS

("SITUATIONS" AND "TRADE")

9d. per word, minimum charge 12/-. No series discount. All charges payable with order. Insertions of radio interest only accepted. Add 25% for Bold Face (Heavy Type). No responsibility accepted for errors. Replies to Box Numbers should be addressed to The Short Wave Magazine, 55 Victoria Street, London, S.W.1.

### TRADE

**AERIAL MAST SECTIONS:** Set of ten 3ft. long by  $\frac{1}{4}$ th inch diameter tubular steel rods, with screwed and socketed ends, for construction as aerial masts, price 50s. the set. **STAY or GUY WIRES:** 30ft. lengths of  $\frac{1}{8}$ th inch galvanised steel at 7s. 6d. Ditto, in 60ft. lengths, 15s.—BRADFORDS, RAMSEY, HARWICH, ESSEX.

**HUNDRED-PAGE Illustrated Catalogue No. 17 of Government and Manufacturers' electronic and mechanical surplus, including a completely new section covering the latest semiconductors and miniature components, with a credit voucher worth 2s. 6d. Send for your copy now, price 3s. post free. The reading alone is worth the money!**—Arthur Sallis (Radio Control), Ltd., 93 North Road, Brighton, Sussex.

**QSL Cards and Log Books, GPO approved, cheapest and best. Prompt delivery.** — Samples from: Atkinson Bros., Printers, Looe, Cornwall.

**QSL CARDS:** Attractive two-colour designs, 25s. per 100. Send s.a.e. for samples. — G3OYI, Cotswold Banks, Honley, Huddersfield, Yorkshire.

**URGENTLY WANTED:** Three-element heavy duty beam. Hy-Gain or Mosley, also a lattice tower, preferably tilt-over. Advertiser can collect in Midlands area. Also Wanted: Good quality rotator unit, with indication. American Sideband transmitter, medium or high power.—Box No. 4487, Short Wave Magazine, Ltd., 55 Victoria Street, London, S.W.1.

## READERS' ADVERTISEMENTS

3d. per word, min. charge 5/-. payable with order. Add 25% for Bold Face (Heavy Type). Please write clearly, using full punctuation and recognised abbreviations. No responsibility accepted for transcription errors. Box Numbers 1/6 Extra. Replies to Box Numbers should be addressed to The Short Wave Magazine, 55 Victoria Street, London, S.W.1.

**WANTED:** Transceiver for 12-volt portable work on 10-15-20m., AM/CW or SSB/CW, mean input to PA not to exceed 50 watts.—G3RFG, QTHR.

**COMPLETE HEATHKIT Station for Sale:** DX-100U with aerial change-over relay plus microphone, RA-1 Rx with QPM-16 Q-multiplier, CL-1 calibrator and matching speaker. All 18 months old, unmodified and unmarked, complete station with all manuals. Price £95 or near offer; will negotiate for items separately.—Heape, G3SZH, Lanchester Hall, College of Aeronautics, Cranfield, Beds.

**WANTED:** AR88D, HRO with bandspread coil packs, cabinets and spares for both; crystals for 40 and 80m.—Field, 43 Overstone Road, Hammer-smith, London, W6.

**FOR SALE:** After abandoned project, wafer switches 9-pole 3-way and 12-pole 2-way, dozens available; samples 2s. 6d. or s.a.e. details.—Austin, 59 Reservoir Road, Olton, Solihull, Warks.

**SALE:** New Kokusai mechanical filter, 2.3 kc, £7. Heathkit reflected power meter, with plugs, £7 or offer. Heathkit GDO with extra-range coils, £9 10s. Grampian DP-4/L microphone, as new, with table stand and two swivel adaptors, £7 10s. or offer. Japanese bug key, £3. G3FIF mobile whip for 80 and 160m., as new, £6 10s. Londex coax relay with plugs, 20s. New "Radiospares" 65:1 mic. transformer, 20s. Xtal for radio control, 27.045 mc, 20s. New Soligor 135mm. f/2.8 tele-lens with Miranda interfex adaptor and lens hood, £21 or offer. Mecablitz 118 flash-gun, as new, complete with leather case, £15 or offer. (Stockport area)—Box No. 4473, Short Wave Magazine, Ltd., 55 Victoria Street, London, S.W.1.

**WANTED:** Well built five-band SSB Tx or exciter. No rats' nests entertained. Full details and price pse. (Dorset area)—Box No. 4474, Short Wave Magazine, Ltd., 55 Victoria Street, London, S.W.1.

## SMALL ADVERTISEMENTS, READERS—continued

**WANTED:** Top Band Tx, AM/CW; also Tx for 10-80m., or transceiver; and a GDO.—Douglas, 51 Wetcombe Avenue, Leeds 8, Yorkshire.

**FOR SALE:** AR88D receiver, price £37 10s. Also a 50-watt Tx, £22 10s. Both in excellent condition.—Wood, G3TAW, 22 Habberley Road, Kidderminster (5628), Worcs.

**WANTED:** Prop-pitch or cowl-gill motor. **SALE:** Modified Command Tx for 40m., CW only, 30s. Mint TCS Tx with home-built PSU and pre-amp., £12 10s. or offers.—G300Q, QTHR.

**WANTED:** CR-100, HRO or similar receiver; up to £20 offered for Rx in good working order. Will inspect and collect within 30 miles.—Smith, 9a Guildford Road, Frimley Green, Camberley, Surrey.

**WANTED:** Commercial Transceiver, AM/CW/SSB, must have its instruction manual. All offers will be acknowledged. Price and details.—Anderson, GM30IV, Maple Cottage, Kirkliston Road, South Queensferry 324, West Lothian, Scotland.

**FOR SALE:** Lafayette KT-340 Rx, coverage 550 kc to 30 mc, aligned and in new condition, excellent performance, price £20. R.1475 Rx, covering 2.0 to 20 mc, in good working order, with PSU, £6 10s.; matching speaker, 30s. Also a new Command Rx, 500 kc to 1.5 mc, 40s.—Jones, G3PSZ, 23 Whitehall Road, Evington, Leicester.

**WANTED:** Air system socket and chimney for 4CX250B series valve. Any reasonable price paid. (Kent).—Box No. 4475, Short Wave Magazine, Ltd., 55 Victoria Street, London, S.W.1.

**WANTED:** Amateur-band converter. **FOR SALE:** Two Phone/CW Top Band transmitters, hi-fi amplifiers, and other gear; no rubbish, offers?—Rowbotham, G2DBV, 12 Eastleigh Road, Prestwich, Manchester. (Tel.: CHE 6866).

**SALE:** Joystick aerial with Joymatch Type 4 matching unit, as new, price £5 10s., plus postage 4s.—Wiggins, 37 Cotswold Street, Cottesmore, Oakham, Rutland.

**WANTED:** Teletype Model 19 printer, Creed 45 Perforator, Muirfax picture receiver, or similar. Also 50-cycle tuning fork unit.—Box No. 4476, Short Wave Magazine, Ltd., 55 Victoria Street, London, S.W.1.

**WANTED:** Heathkit Mohican Receiver; price and full details, please.—Carlisle, G3SRJ, 140 Kingsmead Road, High Wycombe, Bucks.

**WANTED:** Urgently, instruction manual for Eddyson S.640 Rx. Buy or borrow, cash either way.—Bradshaw, 16 Kingsley Avenue, Eastham, Cheshire.

**SALE:** Mobile two-metre Transceiver, commercial headset, boom microphone, h/o aerial. Rx xtal-controlled double super, cascode RF. Excellent performance and commercial appearance. Price £29 10s.—Sanders, G3CRH, QTHR (Tel.: Brownhills 3322).

**REQUIRED:** Heathkit SB-200 kilowatt Linear Amplifier, state price, age of equipment and whether home or factory built. Also **WANTED:** Heathkit SB-610E 3in. monitor scope and HD-10 electronic keyer. (Hants).—Box No. 4477, Short Wave Magazine, Ltd., 55 Victoria Street, London, S.W.1.

**BARGAINS!** BC-312 Rx with internal PSU, speaker and S-meter, £20. Twelve meters, 200 mA to 25 microamp., 10s. to 20s. each. Valves: 813 QV06-40A, QV03-10, at 20s. each. Solartron stabilised PSU, 300/250v. DC, £5. PSU, 350 and 650v. DC, transformer 115/230v., 500 VA, £3. Also ceramic coil formers, variable condensers, etc., £25 the lot, or separately. List available. Buyers collect or arrange.—Lewis, GW3FZV, Dolwerdd, Bwl Road, Nelson (316), Glamorgan, South Wales.

**FOR SALE:** Garrard Lab auto-changer, with stereo arm, £8 or near offer; Plessey auto-changer, £3 10s. Both as new. Also two-metre Tx/Rx, Pye 159-163 mc, complete and with circuit, bargain at £5.—Lewis, GW3FZV, Dolwerdd, Bwl Road, Nelson (316), Glamorgan, South Wales.

**GEORGE FRANCIS G3TWV**

**KW EQUIPMENT AT CURRENT PRICES**  
Midland Agent for Swan

New CDR22R £21; New Eddystone EB36 £54; New Eddystone EC10 £48; New KW600 Lin. Amp. List price £110, to clear at £100.

**SECOND HAND EQUIPMENT**

KW2000 + A.C. p.s.u. New 6146B £160; Codar CR45 £7/10/-; AR88D £33.

This month's bargain—DX60AE, complete with vfo. 90 watts CW and controlled carrier Phone. Unmarked, 1 month old, £56. AR88D in superb condition, £45. Sommerkamp SR100B, £95 and FL200B, £105.

BY100 Silicon Rectifiers 5/- each or 20/- for 5; 10-way min. Group Panels 1/6; 18-way standard 2/-; Key Switches 2/6; 1mΩ Controls with S/P Switch ex-Govt. 6d. each or 4/6 doz.; Set of Allen Keys 4/3; 3 Screwdrivers in case 2/6; Clear Plastic Mains Cable 5d. yd.; pvc brown, black, white, grey 6d. yd.; 23/0076 nonkink 1/6 yd.; Semi-Automatic Bug Keys £4/10/-; Panel Meters 50 μA 32/6, 100 μA 29/6, 500 μA 25/-; M/A Rangers all 22/6; TMK500 £7/17/6; TK25 45/-; Transistor Checker C3021 45/-; 614B 50/-; 572B £7/10/-; Solon Solder Irons 615 26/-, 625 27/4, solder 6d., 2/6, 5/-; 100fc. pvc wire 3/6, 72fc. pvc sleeving in various colours 3/9; Printed Circuit Boards, 1½" x 3½" and 5½" x 8½" 2/- each; Bakelite Sheets 6" x 4" 10d., 8" x 6" 1/5, 10" x 7" 2/-, 12" x 8" 3/-; Veraboard 3½" x 2½" 3/3, 5" x 2½" 3/10, 3½" x 3½" 3/10; Coax Plugs 1/6; Couplers 1/3; Sockets 1/6; American PL259 7/6; Sockets 8/-; Angled Couplers 2/6; Egg Insulators 6d.; Coax Cable 300Ω 6d. yd., 72Ω 7d. yd., low loss 1/10 yd., 52Ω 1/4 yd., low loss 2/4 yd.; Phono Plugs 11d.; Sockets 6d.; Wandler Plugs 5d.; Wandler Sockets 7d.; PP3 Connectors 7d.; PP9 1/-; Test Leads 5/3; Microphone Cable 9d. yd.; Micro Switches 4/-.

**TREAT YOURSELF TO A SHURE MICROPHONE, 444 £9/10/-, 201 £4/10/-.** Hand Mics 15/-, with Switch 19/11; MC70 50/-; MM71 15/-; UD40H 6 gns.; Slim Dynamic B1051 3 gns.; MM18 £4/14/6; BM3 35/-; DF12 £4/14/6; Acos 20/- and 26/-; Foster boom mic £6. Eddystone Dials 843 23/4, 598 37/6, 898 £4/19/-; Speakers 7" x 4" 22/6, 3½" x 3½" 14/3, 3" round 13/9, 5" round 15/-, 6" x 4" 15/-, 8" round 27/9, 12" round 37/6, all 3Ω. Philips 625 tuners complete with IF panel 70/- p. and p. 5/-.

Agents: K.W., T.W., HEATHKIT, EDDYSTONE, FIF MOBILE WHIPS  
R.S.G.B. PUBLICATIONS

No order too small. Part exchanges. Goods dispatched return of post. Postage extra.

93 Balderton Gate, Newark, Notts.

Tel. Newark 4733. After 6 p.m. 2578

**TAURUS ELECTRICAL SERVICES**

Prop.: G3TED

Test Set Type 261. 175-305 Mcs., £2/10/- delivered.  
New useful Flexible Drives, with knob and fixings, 1/9. P. & P. 8d.  
Rotary Converters, 12v. in., 250v. D.C. out., 12/6 each; 12v. in., 490v. D.C. out., 8/- each. Postage on either type 4/6.  
Transistors, A.F., R.F. or mixed, 3/9 dozen, post paid.  
Super Aeraxial Co. Ax., 7.5 ohm, 1/2 yd. Post extra.  
New Ferrite Pot Cores, 1/6 each or 15/- dozen, post paid.  
Transistorized Morse Oscillators will drive speaker or phones, inc. battery, 18/9, post paid.  
4 x 150 Valves, 30/- each; ECC81, 1/9; ECC82, 2/-; ECC83, 3/-; 6BA6, 5/-; 6AQ5, 5/-.. All post paid.  
Magnetic Microphones. Ex-Govt., 5/-, post paid.  
Sound Powered Inserts. Ideal intercom., 3/6, post paid.  
New Mains Soldering Irons, 40 watts, 9/-, post paid.  
New and Boxed Mains Relays, 2 pole 2-way octal base, 17/6. Post 8d.  
New OA90 or OA200 Diodes, 1/- each. Post paid.  
New Co. Axial Relays, 12-24v. operation, 19/6, post paid.  
New Nylon Jack Plugs, 2/6; Jack Sockets, 2/9 or 5/- pair, post paid.  
New TTC Visconal, 500v. .05 Mfd., 4/- dozen, post paid.  
Small R.F. Chokes, 2/6 dozen, post paid.  
Miniature Motors, 2½" x 1½", 12 or 24v., 6/-, post paid.  
Tank Aerials. Three 4' sections making 12', 7/6 extra base sections, 2/6. P. & P. 5/- any number. Bases, 4/6. P. & P. 2/-.  
Breast Sets. Safe for Mobile Operation, 10/-, post paid.  
Xtal Inserts to fit above Breast Sets, 7/6. P. & P. 9d.  
AVO Model 7 Voltage Multipliers, 3/9, post paid.  
Creed 7B Teleprinters. Used, £13. P. & P. 30/-.  
Creed 7B Teleprinters. As new, £30. P. & P. 30/-.  
All spare parts for Creed 7B Teleprinters in stock.  
ATM Filter Units, Control Units and Converters in stock.  
AVO Leather Cases, 14/6, post paid.  
Head Sets. 19 set type or type DLR, 11/-, post paid.  
Small Stand-off Insulators by Eddystone, 1/- each.  
Roller Inductors (SILVER Conductors), 50/-, post paid.  
46H2 Meter Rectifiers. NEW, 1/-, post paid.  
Connecting Lash Up Wire. New 14/0076 mixed colours 50' mixed, 3/6; 100', 6/6, post paid.  
BARGAIN PACKS 1-6. See December issue still available.  
BARGAIN PACK No. 7. Five off S.C.R.'s untested, £1.  
BARGAIN PACK No. 8. Three high speed Polaroid Relays, £1. P. & P. 2/6.  
BARGAIN PACK No. 9. Six 12 volt Vibrators, three of each, two types, £1.  
Standard Army Type Morse Keys. New 5/-.. P. & P. 1/6.  
Dry Battery Packs. 72 and 1½ and 1¼, 4/6 each. P. & P. any number 3/-.  
New Key Switches. Less knobs, 2/6. P. & P. any number 1/-.  
Buzzers, 4½/6v. DC or AC 5/6, post paid.

26 NOTTINGHAM ROAD, LOUGHBOROUGH, LEICS.

Telephone 5131

## HAMMERITE HAMMER PATTERN BRUSH PAINT FOR PANELS, METALWORK, ETC.

TRIAL TIN (covers 5 sq. ft.) only 3/6 + post 9d.

**COLOURS** : blue, silver, black, or bronze.  
2½oz. tins, 3/6. ½ pint, 7/6. 1 pint, 15/-. Very special prices for larger sizes. Carr. up to 5/-. 9d., up to 10/-. 1/9, over 10/-. 3/.

No order too large or too small. All receive prompt attention. **HAMMERITE** produces the cellular pattern known as hammer finish. Just brush on, dries in 20 minutes, withstands 150 C, oil, water etc. Ideal for prototypes, overhauls, etc. Economical to use, easily applied by unskilled labour to any size job, covers 40 sq. ft. per pint, no primer needed.

RETURN OF POST SERVICE, Monday to Friday.

From your component shop or direct from manufacturers:

### FINNIGAN SPECIALITY PAINTS (SW)

MICKLEY SQUARE, STOCKFIELD, NORTHUMBERLAND  
Tel.: Stockfield 2280

## HEATHKIT

The World's largest manufacturer of  
**ELECTRONIC KITS**

We invite you to visit our showrooms at  
233 TOTTENHAM COURT ROAD, LONDON, W.1  
Telephone: 01-636-7349

Send for Free British Catalogue, Dept. TC-4

## DERWENT RADIO

New KW, Swan, Eddystone, Codar, TW, Sommerkamp, etc.

Used Geloso G209 ...	£33	Eddystone 640 ...	£17
Sommerkamp FL200B £115		Eddystone 940 ...	£85
Sphinx De-Luxe ...	£60	Eddystone EC10 ...	£34
Viceroy IIIA ...	£115	Heathkit RG1 ...	£30
Delta AE C/O ...	£4	Hallcrafters 100 ...	£85

28 HILLCREST AVENUE, SCARBOROUGH, YORKS.

## RESISTORS

½ Watt carbon film 5%

All preferred values in stock from 10 Ohms to 10 meg Ohms,  
2d. each.

Send S.A.E. for free sample

## CAPACITORS

Mullard Miniature Metallised Polyester P.C. mounting all 250v.  
D.C. working -01mf, -022mf, -047mf, -1mf, -22mf, all 6d. each.

Please include 1/- for postage and packing on all orders under £1.

Dept. SW2

**Brensall Electronics Ltd.,**  
CHARLES STREET,  
BRISTOL 1

## AMATEUR ELECTRONICS

G3FIK

### COMMUNICATIONS EQUIPMENT

**BC453 COMMAND RECEIVERS.** The famous 'Q Fiver.' Carriage paid £8 19 6

**R209 RECEIVERS.** A new Ministry release of these compact, modern receivers. High performance employing eleven valves with frequency coverage of 1-20 Megs. in four bands. Resolves AM/FM/CW, built-in speaker, operates off 12 volt D.C. ... £15 0 0

**SOMMERKAMP PR100B RECEIVER.** This is not in "as new" condition but is absolutely mint. One only. Including carriage ... £82 10 0

**A 188D RECEIVERS.** We have exceptional fly good stocks of these ranging from used models at £45 to brand new receivers at £72 10. All guaranteed to be in perfect order and alignment. Full details as per our April issue advertisement.

**BC221 FREQUENCY METERS.** A limited quantity only of brand new laboratory standard instruments ... £25 0 0

**LM FREQUENCY METERS.** U.S. Naval version of above ... £16 0 0

**AR88LF RECEIVERS.** A comprehensive selection of these in first class order and alignment from ... £37 10 0

**RCA 8516L RECEIVERS.** A selection starting at ... £155 0 0

**813 VALVES.** Carriage paid ... £2 10 0

Carriage all major items: £0/-, R209's 30/-, Frequency Meters 15/-.

Hire purchase facilities. Equipment purchased. S.A.E. enquiries please.

240 LICHFIELD ROAD, ASTON, BIRMINGHAM 6. Tel. East 1497

SMALL ADVERTISEMENTS, READERS—continued

**EXCHANGE:** Avon 9ft. inflatable boat, complete with all accessories, with Johnson 3 h.p. outboard motor and optional long-range remote fuel tank, whole outfit perfect, cost £150; photograph, or seen North Wales, FOR Eddystone EC-10 in mint condition, with Joystick and £70 cash, or similar deal.—Box No. 4478, Short Wave Magazine, Ltd., 55 Victoria Street, London, S.W.1.

**DISPOSAL:** Lafayette HE-30 Rx, with Q-multiplier, AM/CW/SSB, on behalf owner deceased; price £20 or near offer.—Buchanan, GM3KCY, QTHR (or ring 041-D48-3563).

**DUE Out on May 26, single-copy orders (4s. post free) for the June issue of the Magazine should reach us by Wednesday 24th. Orders, with remittance, to: Circulation Manager, Short Wave Magazine, Ltd., 55 Victoria Street, London, S.W.1.**

**WANTED:** Copies of "QST" prior to 1931; "Radio" before 1940; and "Short Wave Magazine" earlier than 1939.—Lay, G5LY, 226 Riders Bolt, Hurching on, Bexhill-on-Sea, Sussex.

**SALE:** TCS Transmitter, coverage 1.5 to 12 mc, with PSU, price £10; another, less PSU and needs re-wiring, £5. Marconi CR-100 receiver, with S-meter, professionally re-aligned; case restored, and engraved, £25.—Pike, G3WDY, 27 Cintra Park, London, S.E.19. (Tel.: LIVINGSTONE 4738).

**DISPOSAL:** Quantity handbooks and manuals, mostly American Tx/Rx war-time equipment, at 10s. each. Send s.a.e. for list.—G3OEL, QTHR.

**FOR SALE:** Murphy TPG11 Pattern Generator, complete with PSU but less RF unit, price £8 carriage paid.—Cobb, G3UI, 27 Moorlands Crescent, Cousin Lane, Halifax, Yorkshire.

**WANTED:** Copies "Short Wave Magazine" for January, February, March, April and June, 1956; July and August, 1959; February, 1961; and January, 1962. Also low-pass filter and SWR bridge. (Ireland).—Box No. 4479, Short Wave Magazine, Ltd., 55 Victoria Street, London, S.W.1.

**FOR SALE:** Heathkit RG-1 receiver with Codar preselector, both as new, £45 or offer; also AR88LF Rx, re-wired p.v.c., with S-meter but no case, £35. Will deliver in North Wales, or carriage extra.—Lane, GW3MQX, 4 H.M. Coastguard Station, Holyhead, Anglesey, North Wales.

**SALE:** Portable Gear, including three Command transmitters, modified for 12v. heaters coverage 20-80-160m., with 1625 PA, switched and metered, price 40s. each. Two matching Command receivers, for 80 and 160m., 40s. each. Also a Bendix TA-12B Tx, CW only on 20-40-80m., 50s. A.M. Type for 247 PSU, 600v. DC/24v. AC, £3. PSU Type 3. for R.1132 Rx, 40s.—Munt, G3KTA, 130 Chipstead Way, Woodmansterne, Banstead, Surrey.

**SELLING:** CR-100 receiver, with noise limiter and speaker, price £15. Also Codar PR-30 preselector, £4.—Angerson, 35 Parkside Road, Leeds 6, Yorkshire.

**WANTED:** General coverage or amateur-bands-only receiver. Need not be working but should be more or less complete, and must be cheap. Full description, please, of make, type, condition and price. (Yorkshire).—Box No. 4480, Short Wave Magazine, Ltd., 55 Victoria Street, London, S.W.1.

**WANTED:** Tunable receiver covering 150 to 200 mc. Please state model, condition and price.—Jeffries, 5 Glenferness Avenue, Bournemouth, Hants.

**WANTED:** Good BC-348 receiver; also a good Sphinx, Vespa or Viceroy transmitter. State condition, modifications, age, price, etc. (East Lincs).—Box No. 4481, Short Wave Magazine, Ltd., 55 Victoria Street, London, S.W.1.

**SALE:** Star SR-600 receiver, excellent performance and appearance; has had very little use. With manual and spare xtals, in makers' packing. Best offer over £60 secures. (Yorkshire).—Box No. 4482, Short Wave Magazine, Ltd., 55 Victoria Street, London, S.W.1.

# FIRST AWARD

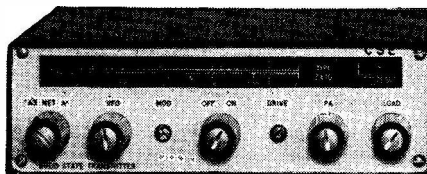
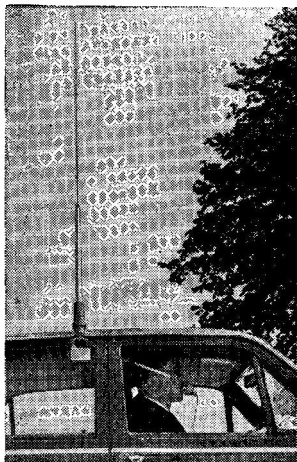
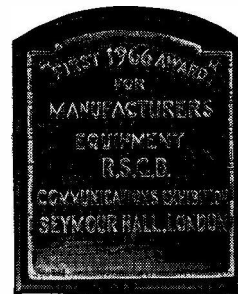

**TRANSMITTER**  
Type 2A10  
£43.7.0 U.K.

**SILICON SOLID STATE**  
DIRECT BATTERY OPERATION  
AMATEUR 2 Mc BAND

**RECEIVER**  
TYPE 2AR  
£44.0.0 U.K.

**PORTABLE — MOBILE — FIXED**

**AERIAL — TUNED — WINDOW MOUNTED — TYPE 2ATMA: £9.15.0 U.K.**

**MICROPHONE — SPECIAL — EMERGENCY SAFETY RELEASE: £2.17.11 U.K.**

**FULL DETAILS FROM**

**CONTACTOR SWITCHGEAR (ELECTRONICS) LTD. WOLVERHAMPTON 23883**

7116

SMALL ADVERTISEMENTS, READERS—*continued*

**"RTTY—The Easy Way"**: Now in its second printing, the British Amateur Radio Teleprinter Group's factpacked booklet costs only 3s., post free. Remittances payable to BARTG, please.

—Owen, G2FUD, 184 Hale Road, Hale, Cheshire.  
**SPRING Cleaning!** G.44 Signal Generator, modulated, coverage 250 to 500 mc, with diagrams and charts, £4. R.220 modified for 70 mc, with circuit and data, 60s. Leyland audio oscillator covering 1 kc to 20 kc, 250v. AC, £8. Type 106 Signal Generator, with CV-35 klystron, for 180v. AC, £4. Test Set, 20-45 mc and 40-100 mc, 6v. input, 50s. Cavity wavemeter, 100 to 700 mc, six valve, no data, 60s. Radar Tx/Rx test set, Type 102. 24v. input, £5. Labgear TV pre-amp for Band III, 250v. AC, 25s. VCR-139A CRT, 10s. TR.3582A, with RF-25 Unit, unmodified, 30s. BC-1000 transceiver, 18 valves, with p-t-t headset and circuit, 30s. TR.1475, with 6-3v. valves, working but needs attention, 70s. Pye mobile Tx/Rx, suitable 12v. mobile, 40s. All carriage extra, s.a.e. with enquiries.—Thorburn, G3WBT, 27 Banklands, Workington, Cumberland.

**SALE:** R.206 receiver, unmarked and in as-new condition, with its PSU, price £24; will deliver or arrange carriage U.K. Also offering copies "Practical Wireless," March 1958 to October 1962; "Practical Television," March 1960 to September 1962 (except May 1960); and "Good Photography," September, 1965 to August, 1960—offers? (Somerset).—Box No. 4483, Short Wave Magazine, Ltd., 55 Victoria Street, London, S.W.1.

**WANTED:** Transmitting Valves 813 (or 4B13), and 811.—Bryan, 3 Guildford Close, West Worthing, Sussex. (Tel.: Worthing 6'51).

**ASKING** Only £30, for a Heathkit RA-1 amateur-band receiver, in good condition, with xtal calibrator and recently realigned.—Mitchell, 7 Beaumont Street, Oxford.

**BARGAIN!** Trio 9R-59 receiver, coverage 535 kc to 30 mc, with full electrical bandsread, calibrated over amateur ranges, SSB, variable selectivity, aerial trimmer, etc. As new, but slightly modified for more gain and greater selectivity and to improve tone, with handbook, price £20. **WANTED:** "QST" for March, 1962.—Simpson, 33 Keymer Road, Hassocks, Sussex. (Ring Hassocks 3168, day only).

**WANTED:** An R.C.A. AR-8516L Communications Receiver. Would exchange new Asahi Pe tx Spotmatic f/1.4 super Takumar Camera.—Elkin, 10 Winterslow Drive, Leigh Park, Havant, Hampshire.

**SELLING:** A KW-77 receiver, at £75. Also a K.W. Viceroy SSB Exciter unit, £50. Both in excellent condition.—Cheffings, G3NGE, Grimoldby, Louth, Lincs.

**WANTED:** At a reasonable price, a National HRO or Marconi CR-100 receiver, in nice clean condition and with its manual. Full details, pse.—Barnard, Lulworth, Rushmoor Avenue, Hazlemere, High Wycombe, Bucks.

**FOR SALE:** Sphinx SSB Tx, coverage 20-80-160m., price £55. Heathkit Comanche Rx, 10-80m. amateur bands, xtal filter and with PSU, £35.—Gates, G3ENB, 1 Stonecross Road, Castle Park, Whitby, Yorkshire.

**BARGAIN:** Admiralty B.36 receiver, triple conversion, coverage 1.0 to 20 mc, in good working order.—Debenham, 33 Tennyson Avenue, New Malden, Surrey. (Tel. 01-942-7241.)

**FOR SALE:** Eddystone S.750, in excellent condition and unmodified, with matching speaker and S-meter, also circuit. Price £35, buyer collects.—Ring Dixon, High Wycombe 21615, evenings or weekends.

**SELLING:** Heathkit Mohican receiver, in good condition, £15, buyer to collect. Also Scarab crystal filter kit, unused, £5.—Dewhurst, G3VFR, QHTR.

**NEW 1967**  
24 page illustrated list  
of  
**Valves - Transistors, SCR's, Zeners, Tunnel Diodes, F.E.T's, Photo Devices, Quartz Crystals, 1/-.**

Completely  
New Edition  
2,000 listed Devices  
Have you sent for your copy!

**1967 CATALOGUE**

Completely  
New Edition  
200  
Packed Pages  
Fully illustrated  
10/- DISCOUNT  
VOUCHERS enclosed with every  
copy.  
Price 8/6  
Post paid.



**HENRYS RADIO Ltd.** PAD 1008/9  
303 EDGWARE ROAD, LONDON, W.2 Mon.-Sat. 9-6 p.m.  
Thurs. 9-1 p.m.

**NEW STYLE PRESELECTOR**



This is a pentode pre-amp for the Rx covering 1.6 to 32 Mc/s. in 6 bands, with large 1 1/2" diameter high "Q" coils, air spaced on the HF bands. It also has a built-in Pi tank antenna tuner of Tx design, enabling any length of wire or type of antenna to be used efficiently.

**HAMGEAR ELECTRONICS**  
29 CARLYLE ROAD, NORWICH

£6. 18. 0  
S.A.E. for 3-page illustrated leaflet.

£3-3-0 per 1000  
£2-2-0 per 500

**QSL CARDS**

Our unique cards are currently the best value available in the U.K. Extremely attractive, 2-COLOUR design on quality card. Prices quoted include Postage & Purchase Tax.

Why not write for a sample?  
For All your printing requirements.....

**ARA PRESS** 68, Banks Road, Coventry.

**YUKAN SO PROFESSIONAL THE YUKAN SELF-SPRAY AEROSOL WAY -**

Get these AIR DRYING GREY **HAMMER** or BLACK **WRINKLE (CRACKLE)** Finishes

Yukan Aerosol spraykit contains 16 ozs. fine quality durable easy instant spray. No stove baking required. Hammers available in grey, blue, gold, bronze. Modern Eggshell Black Wrinkle (Crackle) all at 14/11 at our counter or 15/11, carriage paid, per push-button self-spray can. Also Durable, heat and water resistant Black Matt finish (12 ozs. self-spray cans only) 13/11 carriage paid.

**SPECIAL OFFER:** 1 can plus optional transferable snap-on trigger handle (value 5/-) for 18/11, carriage paid. Choice of 13 self-spray plain colours and primer (Motor car quality) also available.

Please enclose cheque or P.O. for total amount to:  
**YUKAN, Dept. SW5 307a Edgware Rd., London W.2.**  
Open all day Saturday. Closed Thursday afternoons.

Other Yukan Air Drying Aerosols include:  
Zinc Chromate Primer.  
Clear Lacquer.  
Anti-Tarnish Gold and Metallic Finishes.



## SMALL ADVERTISEMENTS, READERS—continued

**SALE:** Eddystone items, Type 709 two-metre PA tuner, new, 30s.; Type 835 230 mmF variable condensers, rated 1-25 kV, new, 12s. 6d. each; pair Rx mounting blocks, to give slope, also new, 12s. 6d. B. & W. phase-shift network, Type 2Q4, new, 40s. Labgear RF choke, rated 150 watts, 15s. Geloso 4/102 VFO, complete, £5. Collaro Transcriptor tape-deck, with Maestrovox amplifier, as new, £8 10s. Jason Wobbulator, new, £9. G.E.C. "Miniscope" CRO, £8. Valves: 4CX250B, new, £4 each; bases, 30s.; 829B, 15s.; 6CD6GT, 10s. Crystals: 7-01, 8-10 mc, Ch.49. Ch.50, 10s. each. Acos microphones Type Mic.30 and Mic.36, 20s. each. Jap S-meter, 20s. **WANTED:** K.W. E-Z Match unit.—Hope, G3MGT, 35 Porton Court, Surbiton, Surrey.

**SELLING:** Five 7B Teleprinters, one complete, four for spares, £20. Accumulators, 12v. 75 A.H., brand new, £4 10s. Evershed Bridge Megger, in leather case, perfect condition, £20. Philips 5-watt amplifier, in wood cabinet, £3. Carriage extra all items.—Hirst, 60 Garstang Road South, Wesham, Kirkham, Lancs.

**WANTED:** 10XJ type unsealed crystals, 6200-6210 kc; any half-inch mounting xtals, 8000-8150 kc. **AVAILABLE:** Small quantities ammonium bifluoride crystals, enough for numerous etching solutions, 5s.—Grav, G3VAJ, Swithlands, Falkenham, Ipswich, Suffolk.

**WANTED:** In mint condition and unmodified, a Marconi Alignment Oscilloscope Type Tr-052 (or later model); SFC battery charger Type Zs.10234 (or similar Westinghouse model) giving at least 20 amps. at 24 volts; STC rectifier unit Type 11, ZB.10235; CR-91 with original S-meter; an R.5032A Rx; and a Lafayette HA-55A receiver. **FOR SALE:** Latest model Zenith Trans-Oceanic FM/AM Portable Royal 300J-1, new, £80; R.C.A. AR77E, good condition, £18; AVO Model D, as new, £7; Hallicrafters S.37, good condition, £42; Hallicrafters S.37/S.36, fair condition, £20; Hichok 188 Signal Generator, £15.—Box No. 4484, Short Wave Magazine, Ltd., 55 Victoria Street, London, S.W.1.

**SALE:** Type 13A 5in. double-beam Oscilloscope, £465/915 kc transistorised wobbulator, £20. Type 1632 Signal Generator, 100 kc to 120 mc, with crystal marker and output meter, £15.—Boyce, G3PZA, 73 Maida Vale Crescent, Coventry, Warwickshire (or ring G3PQQ, Coventry 22714 before 7.30 p.m.).

**SALE:** A G3HTA-type receiver, all new parts, but it needs a complete rebuild, going at £20.—Angerson, 35 Parkside Road, Leeds 6, Yorkshire.

**FOR SALE:** Factory-built HE-30 receiver, with manual, in new condition and hardly used, price £20 or nearest, buyer to collect or will deliver to 30 miles.—Lister, 4 Hightorne View, Armley, Leeds 12, Yorkshire.

**WANTED:** Pair of bases for 4X150's, also valves type 4-125A and QY3-125. **SELLING:** 807 with 12v. heater, suitable mobiles.—Parker, G3OV, 133 Station Road, Cropston, Leicester.

**WANTED:** Copies of "Short Wave Magazine" for September 1952, April 1953 and August 1958. Alternatively, would be grateful for AR88D modification data contained in these issues.—Purser, P.O. Box 9, Mbabane, Swaziland, Africa.

**SELLING:** National HRO, rebuilt with cascade RF stage, product detector, noise limiter, xtal calibrator, etc., with bandspread coil packs for 10-20-40-80-160m. plus two GC, with PSU, speaker and original manual, £22 the lot. A 6-volt vibrator PSU for AR88, unused, 15s. Rotary converter for 19 Set, 15s. RF-24 Unit, 15s. Unused 5B/254M, 20s. TT21, 25s.; AUY10. 2N1907, 20s. each. Wavemeter Type TS-184/AP for 70 cm., with manual, 40s. Pre-amp for 70 cm., using A.2521, 30s. Frequency standard for 100 kc. with internal PSU, 40s. G.E.C. Miniscope, needs some attention, 40s. Also assorted crystals, valves, transformers, meters and so forth—call round for a rummage. Carriage extra priced items. but could deliver to 50 miles.—Taylor, G3NNW, 31 Birch Hill Crescent, Rochdale, Lancs.

## SMALL ADVERTISEMENTS, READERS—continued

**SALE:** BC-348R, little used, with internal semi-conductor PSU and handbook, price £12; buyer to collect or would deliver locally. Also a Heathkit RF-1U signal generator, coverage 100 kc to 200 mc, built professionally and in as-new condition, price £10.—Fletcher, G3VTM, 10 Cedar Walk, Bottisham (270), Cambs.

**BARGAIN!** A 19 Set in fair condition, with mains PSU for Rx. PSU requires BY100. Price £4 or near offer? Prefer buyer inspects and collects, or carriage extra.—Baxter, 7 Woodside Gardens, Tottenham, London, N.17.

**SELLING:** Geloso VFO Type G4/105, xtal control, complete and new, £15. Pair of TT21's, new, 50s. Geloso PA coil unit, 10s. American B. & W. coil, wound to 10 t.p.i., 2½ in. diameter, ideal for PA or ATU. 10s. Pair of vernier tuning dials, ex-Tu, 7s. Air Ministry type heavy brass Morse key, 3s. 6d. Trolex wafer switches, 2-pole 5-way, with shaft, new, 8s. Jason FM tuner, 50s. or near offer?—Box No. 4485, Short Wave Magazine, Ltd., 55 Victoria Street, London, S.W.1.

**FOR SALE:** Douglas No. 1 Coil Winder, by AVO, £12 10s. R.C.A. AR88D, in very good condition, £35. K.W. Vespa Tx, very little used, £85. BC-221, no charts but with some calibration, £10. Signal generator, E.M.I., coverage 30 kc to 100 mc, £12. Zyto 3½ in. B.G.S.C. centre lathe, motorised, with 3 and 4 jaw chucks, drill chucks, etc., £45. Crystal frequency marker, 10 kc and 100 kc, with internal PSU, £8. Frequency meter for UHF, 300 to 1000 mc, 4 in. 200 microamp meter, with charts, £10. Industrial Electronics 3 in. 'Scope, with matching wobblator, £15. Vibrating reed frequency meter, for VLF 36 to 63 cycles, £4. BC-376A Test Set, with crystal and PSU, 50s. Dynamic Mutual Conductance Valve Tester Type 1-177B, £10. Eagle K-142 Valve Voltmeter, brand new, £12. Linear amplifier, 10-80m., pair 813 plus massive PSU with Variac input, capable one kilowatt, £10. B.29 Rx. coverage 15 kc to 560 kc (looks like a CR-100), £5 10s. A good Teletype 19 'printer, with perforator, £18; Teletype 14 transmitter distributor, good, £6; PSU for Printer and Distributor. £4 10s. DL6EQ-type terminal unit, with PSU, £5. Two-tone oscillator, as DL6EQ, 60s. Audio oscillator, coverage 150 cycles to 3000 cycles, 80s. Another audio oscillator, 450 cycles to 20 kc. 50s. Also several odd meters from 5s., valves and crystals for two-metre work; transformers, chokes, etc.; write for details, with s.a.e. No offers accepted for priced items, which are strictly as quoted. Prefer buyers to inspect or collect, otherwise delivery charged extra. Telephone will be answered 6.30 to 9.30 p.m. Monday to Friday for four weeks from April 28.—Cavill G3SBH, Quarry Farm House, Cam, Dunsley (2907), Glos.

**FOR SALE:** Receivers R.1475, coverage 2.0 to 20 mc, complete with PSU, £12 10s., carriage 12s. 6d. Without power pack and in working order, £8 10s., carriage 10s. Money order only, please.—Goble, 115 Dvas Road, Great Barr, Birmingham 22A.

**GOING ABROAD:** Heathkit DX-100U, immaculate condition, tested, but otherwise unused. R.C.A. AR88D, very good condition. Both these items complete with manuals—offers? Woden UM-1 mod. transformer, unused, 60s.—Phone Duxbury, Winterbourne Gunner 230 (Wilts), or write: Box No. 4486, Short Wave Magazine, Ltd., 55 Victoria Street, London, S.W.1.

**SELLING:** Eddystone S.640 receiver, with matching speaker and S-meter, stabilised oscillator for SSB reception, in excellent condition, with original carton, £25. B2 Tx/Rx, complete with coils and PSU, modified for Top Band, shipped in original metal water-tight cases, FB condition, £15.—Taffer, G3BJT, 29 Unwin Avenue, Bedford, Feltham, Middlesex. (Tel. 01-890 6487, after 7.0 p.m.)

**SELLING:** Hammarlund HQ-170, first-class Rx in perfect condition, with original carton. £90 or near offer?—Braham, G3OJS, Tel. Seven Kings 0197.

## S.S.B PRODUCTS

## Derby

**"PYRAMID"** Linear. 80-10m. 800w., 1/P. Genuine 400 watts O/P all bands. Built-in power unit. Size: 14½" x 6" x 11½" deep. Modern design. Any colour to match other gear "Easy to Drive." Where else can you get a complete set of parts like this for under £50! Only quality parts used, £49/15/- + 25/- carriage. Write for details!! S.A.E.

**"SPHINX"** Transmitter. Latest model with refinements The Tx that has what other makes leave out—an audio freq. response that gives readability and talk-power! Each of our filters (Scarab) are aligned most carefully. Every Tx has a most careful inspection and is "air" tested. 75-80 watts P.E.P. 160m., 80m. (40m.), 20m. (with O/P socket to feed 15/10m. adaptor). Built-in power unit, most modern in appearance £78 std., £84 de-luxe. Terms and part exchanges.

**"HA350"** Receiver. 160-10m. xtal controlled front end. Covers bands in 500-600 Kc/s. steps. Very stable and easily the best buy for the amateur looking for a new receiver which is value for money! Has mech. filter, etc., etc. Write for details, 80 gns. (or 80-10m. 75 gns.). Terms and part exchanges.

**"SCARAB"** xtal filter kit inc. carrier xtal (436 kc/s.) I.F.'s, Mics, etc. £6/19/6, 2/- p. & p. Ready made and aligned for excellent speech quality, etc., size: 3" x 2" x 1", £8/7/6, 2/- p. & p. Uses new miniature xtals. Undoubtedly the best buy in Filters. All details on circuitry around filter sent.

**"DELTA"** Co-ax Relay Unit. Controls Tx and Rx. Robust and excellent value at £7/5/- (6/-).

**"NAPOLEON"** S.W.R. Bridge. Sens. control. For/Ref. SW. 800w. to 10w. 70-80Ω. Well made and most important of all "it is accurate." Price only £5/5/- (4/6). Why pay more?

**"CANNONBALL"** Tx. Smallest S.S.B./C.W. Available 1-8 to 2 Mc/s. Size: 8" x 6" x 6". Pi-tank O/P. Very well made. Good value. Also 12v. and 3.5-4 Mc/s. models, £33 (7/6).

**"SILPLUG"** Rect. Units. Still selling well. Quality product. 500v. ½ amp., 39/6. 750v. ½ amp., 49/6 (1/3).

**CLASS "D" WAVEMETERS.** SPECIAL OFFER. Converted to 240 A.C. 1/P. Fully smoothed and recalibrated. With handbook and phones, £6/19/6 each, carriage 8/6.

## OTHER NEW LINES IN STOCK

BY RETURN POST—SAFELY PACKED

**SPHINX CABINETS, LATEST.** 6-colours available (size as Pyramid) flush lid, removable base plate, only 79/6 each, 8/6 carr.

**BUG KEYS, KY102, 85/- and 4/6 p. & p.**

**ELECTRONIC KEYS, D.A.I., £16/10/-, 4/6 p. & p.**

**G.D.O. Lafayette, £12/10/-, 3/6 p. & p.**

**DYNAMIC MICS.** Selected for S.S.B. TX's. DM16. DM21 99/- each, 3/6 p. & p. BM3 xtal mic, only 33/6 (3/6).

**6HF5 valves, 31/6 each, 2/3 p. & p. Brand new.**

**6146 valves, 30/- each, 2/3 p. & p. Brand new.**

**6HF5 Bases, 4/- each (6d.).**

**HA350 MECH. FILTERS, £9/10/- each, 2/- p. & p.**

**VALVE VOLTMETER. 6" scale—30 range, £15 (6/-).**

## RECONDITIONED RECEIVERS, etc.

**EDDYSTONE 640.** Overhauled, £25.

**HEATHKIT RA1, £33.** Excellent condition.

**1475 RX.** Extremely stable, 2-20 mc/s., £12/10/- (15/-).

**PWR UNIT.** For 1475, 12v. A.C. mains 1/P, £6 (10/-).

**MOHICAN.** Transistorised with A.C. Eliminator, £33.

**EDDYSTONE 750 and Mains Filter.** This Rx. is in very good condition, £45 (20/-).

**A.V.O., type "D."** Good buy, £9 (7/6).

7A EDWARD ST. DERBY 42909

# G. W. M. RADIO LTD.

## RECEIVERS

**RI475.** 2-20 Mc/s. Large slow motion dial, etc. with original power unit for 12 volts D.C. or 230 volts A.C., £13/10/-, carriage paid.

**CANADIAN MARCONI 52.** 1-75 to 16 Mc/s., 13 valves, etc. with ZE12 power unit for 115/230 volts A.C., £13/10/-, carriage paid. Reprinted handbook with all circuits, 5/-.

**R209.** 11 valves. 1 to 20 Mc/s. 12 volts D.C. input, £15, carriage £1. For callers only **MARCONI B28 (CR100)** from £18/10/-, R107, £10.

**OSCILLOSCOPES.** Cossor 1049, £17/10/-; 1035, £20 or 339, £11, carriage paid.

**TRANSISTORISED MAGNETIC BROADCAST RECEIVERS,** vest pocket size. Battery operated. Fixed frequency. Epoxy resin block construction.  $\frac{1}{2} \times 4\frac{1}{2}$ " Ferrite rod aerial. No other information. Used, good condition, 10/-, post 2/6.

**10X TYPE CRYSTALS,** 100 or 1000 Kc/s., 12/6 either post paid. Original dry batteries for 18 set, 10/- or 38 set, 8/6 post paid. Recent manufacture.

**RECEIVERS.** Admiralty B40. 640 Kc/s. to 30.5 Mc/s. 14 valves. Speaker, A.C. power unit built in. Bandwidth switched, 1, 3 and 8 Kc/s. Crvstal calibrator. Large vertical calibrated illuminated dial. Circuit diagram, £25, carriage 30/-.

**EX-R.A.F. ASTRO COMPASSES** in original wood cases, 31/6, post paid.

**RACK MOUNTING POWER UNIT TYPE 3,** 230 volts A.C. outputs 250 volts D.C. 100 m/a 6.3 volts 4 amps., 70/-, carriage paid.

**METERS.** 2 $\frac{1}{2}$ " round flush. Rectifier type A.C. 0-10 M/a, 0-50 M/a, 0-5 volts, 10/- each. D.C. 0-100 volts, 0-500 volts, 12/6 each. D.C. 0-50 Mic/amps, 25-0-25 Mic/amps, 0-500 Mic/amps, 17/6 each. 3 $\frac{1}{2}$ " flush round 0-100 Mic/amp, 30/-, Post 1/6 per meter.

All equipment offered is complete but not tested unless otherwise stated. Carriage charges quoted are for England and Wales only. Telephone Worthing 9097.

Terms: Cash with order. Early closing Wednesday.

**40-42 PORTLAND RD., WORTHING, SUSSEX**

# STEPHENS - JAMES LTD.

Equipment supplied by KW Electronics, Codar, Drake, Hy-Gain, Electronics, Eddystone, National, Green E.C.E., Joystick, Eagle, Lafayette, Sommerkamp.

**KW2000A, £220. KW Vespa, £120. KW201, £105. KW600 Linera, £110. SWR Bridge, £8/10/-, PEP meter, £12/10/-, KW E-Z Match £12/10/-, KW Balun, 35/-, "Q" Multiplier suitable for the KW201 and KW2000A, £8/10/-, Trapped dipole, £9.**

## Hy-Gain Antenna range

**TH3 Mk. 2** Tribander three element, 8 dB gain. Weight 36 lb., £52.  
**TH6DX** Triband six element, 9 dB gain. Weight 47 lb., £70.  
**204BA** four element for 20m., 9.2 dB gain. Weight 40 lb., £52.  
**TH3 Jnr.** Triband three element, gain 8 dB. Weight 21 lb., £32.  
**Verticals.** 16AVQ, £25; 14AVQ, £15; 12AVQ, £12; Hy-Gain Balun, £6.

**Codar** transmitters, receivers, preselectors, "Q" multiplier, control units, AC and DC psu's.

**Drake 2C** receiver ... £99  
**New R4X** receiver ... £1-5  
**Matching T4X** ... £185  
**TR4** Transceiver ... £265

**Sommerkamp FR100B** ... £112  
**Sommerkamp FL200B** ... £130  
**Sommerkamp FL1000** ... £90

**Shure 201** mics ... £4 10 0  
**Shure 444** mics ... £10 10 0  
**Shure 245S** mics ... £12 6 8  
**Semi-automatic bug keys** £4 12 6  
**75 ohm co-ax** ... yd. 1/-  
**52 ohm co-ax** ... yd. 1/7  
**300 ohm ribbon** ... yd. 6d.  
**Egg insulators** ... each 6d.  
**"S" meters** ... 29/6  
**QSL cards.** 6d. stamp samples.

**3F1F Mk. 2** Whips ... £7 7 0  
**3F1F Mk. 3** Whips ... £9 19 6

**Joystick.** Full range of antennas and tuning units.

**National NCX5** transceiver complete with psu ... £300

**Trio 9R-59** ... £35  
**HA350** ... £78 10 0  
**CR70A** ... £19 10 0  
**Lafayette HA55** ... £19 7 6

**PCR** spkr. and int. psu £7 0 0  
**SR550** as new ... £45 0 0  
**Mallcrafters HT40** ... £30 0 0  
**Codar AT5** ... £12 10 0  
**AT5** homebrew psu ... £17 10 0  
**AT5** and psu ... £15 0 0  
**BC221** ... £20 0 0  
**HE40 Rx** ... £12 10 0  
**KW77 Rx** ... £80 0 0  
**AR88D** ... £40 0 0  
**KW77 Rx** ... £80 0 0  
**Eddystone "S"** meter ... £3 10 0  
**KW Vespa** ... £95 0 0

## HP TERMS - PART EXCHANGES

Post and packing extra. Enquiries S.A.E. answered by return

Hours : 9 a.m.-6 p.m. Half day Wednesday. No parking problems.

**70 PRIORY ROAD, ANFIELD, LIVERPOOL 4** Tel (051-ANF 7829)  
 We are approx.  $\frac{1}{2}$  mile from Liverpool and Everton Football grounds.

## SMALL ADVERTISEMENTS. READERS—continued

**FOR SALE:** Mains operated intercomm. unit with one out-station and about 200 yards of 4-core screened waterproof cable, £5. Heathkit Q-Multiplier, QPM-1, £5. Pair of RG1-240A rectifiers, new, 20s. **WANTED:** Bell-Howell 16mm. sound projector; any model between 601 and 640; condition unimportant. —G3LGL, QTHR (or ring Cradley Heath, Staffs, 69970).

**WANTED:** RSGB "Bulletin" for July and August, 1964.—Elvins, 40 Willow Road, Bromsgrove (6149), Worcs.

**SALE:** Eddystone 940 receiver, with speaker and headphones, as new, £45. Philips stereo 4-track tape recorder, Model EL3536, £45.—Szmldt, 520 Whalley New Road, Blackburn, Lancs.

**FOR SALE:** Heathkit RA-1 amateur-band communications receiver, in as-new condition, £30 or near offer?—G. & D. two-metre converter, £3.—Clarke, 162 Redhouse Lane, Aldridge, Staffs.

**WANTED:** For VHF/UHF work a Discone Antenna; full details, please.—Box No. 4488, Short Wave Magazine, Ltd., 55 Victoria Street, London, S.W.1.

**SELLING:** AR88D, in case, £35; also AR88LF, in case, £33, in excellent electrical and mechanical condition. Eagle RX-60N, coverage 550 kc to 30 mc, new 12 weeks ago, £17 or near offer? Cossor 339 D-B "Scope, requires attention, complete with companion wobblator, £11. Advance Type E.1 Signal Generator, 100 kc to 60 mc, with manual, £10. AVO Signal Generator, 80 kc to 80 mc, £7. Minimitter Miniciter, £8. Taylor 45C Valve Tester, immaculate and complete with manual, £11. Eddystone S.640 Rx, coverage 1.7 to 30 mc, £17.—Lord, G3PHN, Newfield House, Moira, Burton-on-Trent, Staffs. (Tel. Swadlincote 7537.)

**FOR SALE:** In mint condition, with operating and alignment instructions, Jennen Trio Model JR-102 communications Rx, coverage 540 kc to 30 mc, also 142-148 mc (two-metre band), with Q-multiplier, product detector, crystal calibrator, ANL, AVC, MVC, bandspread all amateur bands, with S-meter, etc., for CW/FM/SSB price £40 or nearest. Prefer buyer inspects and collects, if possible.—Flynn, 8 Springwood Gardens, Parkside Estate, Bradford 5, Yorkshire.

**WANTED:** Heathkit DX-100U, or similar 10-160m. Tx, in good condition.—Stork, G3VUU, 20 Oakdale Avenue, Wibsey, Bradford 6, Yorkshire.

**FOR SALE:** Hammarlund HQ-170A, in beautiful condition, no mods, and with handbook, £85. Labgear 160m. Tx, £13. Salford Signal Generator Type 106, 5 to 55 mc, with all leads and charts, as new, £8. Labgear PSU, 300v, at 130 mA, £3 10s. Variac, Claude Lyons, rated 2 kW, £7. Modulation xformer, for 2/807 into 813, 20s. Delivery by arrangement.—Beech, G3PVL, 45 Blackgate Lane, Tarleton, Preston, Lancs. (Tel. Hesketh Bank 2855.)

**SELLING:** B.44, 90s. BC-620F transceiver, handset, PSU 6-12-24v, 80s. T.1145N Tx, less 100 mA meter, 60s. R.3582A Rx, mains, with RF-86 unit, 50s. R.209, 12-volt, covers 1-20 mc, £11. Pye VHF-PTC Rx, 12-volt, 60 to 100 mc, 30s. Mains Rx, LW/MW/SW, 40s. ATU for 52 Set, 25s. Variometer, 19 Set, 10s. Mains transformer, 5000v, 30 mA, 20s. Type 2M crystal for 1774 kc, new, 20s. Vibrator Unit for 22 Set, 30s. Carriage extra.—Raybould, 16 Brookbank Road, Bornal Wood, Dudley, Worcs.

**FOR SALE:** Eddystone 358 Rx, in good condition, complete with PSU, coils and manual, price £15, buyer to collect.—Elcocks, G3R1X, 223 Perry Wood Road, Great Barr, Birmingham 22A. (Tel. GRE 3756.)

**SALE:** G8KW-type Balun, unused, 20s. New H.D. coax, 72-ohm, 33 yards, 20s. G8KW SWR indicator, 52-ohm and 75-ohm, unused, £5. Trap dipole, G8KW, with 75 feet coax, £5. Olympic Z-Match, 250-watt model, with dummy load, 10-160m., £5. Metal plinth, with speaker, suitable HRO, G.209R, etc., 20s. Carriage extra.—Box No. 4489, Short Wave Magazine, Ltd., 55 Victoria Street, London, S.W.1.



SMALL ADVERTISEMENTS, READERS—continued

**FOR SALE:** In good condition, 19 Set Mk. III, Tx/Rx works, but internal mains PSU for Rx only, £6 10s. Dynamotor, 12-volt, 22s. 6d. Five-valve superhet, coverage medium-wave to 30 mc, with PSU but less cabinet, £3 10s. Garrard gram. motor, 12s. Offers? Valves: EF80, 6BW7, 6K7, 6K8, 1s. 6d.; EF36, 2s. All letters answered.—Kinnersly-Taylor, Seaton Ryde, Tranwell Woods, Morpeth (2541), Northumberland.

**EXCHANGE:** Omega "Speedmaster" wrist stop-watch, cost £58 new, recent Swiss factory overhaul, with built-in tachometer (average speed indicator), will measure from 12 hours to one-fifth second, on stainless steel bracelet **FOR** General coverage communications receiver, such as Lafayette KT-340 or Eddystone EC-10. Also **EXCHANGE** 19 Set (Rx only) in **FB** condition, plus TR-101 Mk. I PSU, **FOR** Joystick VFA.—Driver, 105 Main Street, Bingley (3217), Yorkshire.

**WANTED:** Portable Transmitter-Receiver Type B.P.5 (or Type 5) complete with power units. Also automatic Morse transmitter and tape-punch. Good price paid for these items.—Gee, 11 Whitehorse Lane, Stepney, London, E.1.

**SELLING:** K.W. Vanguard, 10 to 160m. model, in nice condition but less 6146 valve, price £25.—Lee, G3OPP, 7 Standard Road, Downe, Orpington, Kent.

**FOR SALE:** Labgear LG.50 transmitter, 60 watts **FAM/CW** on 10 to 80m., price £25 or near offer, delivered free to 80 miles.—Morris, G3LSY, 16 Locket Road, Wealdstone, Harrow, Middlesex.

**SALE:** Swan Model 240 tri-band Transceiver, with AC/PSU and p-t-t microphone, price £120.—Heiman, 16 Barton Road, Langley, Bucks. (SL4-2916.)

**SELLING:** BC-454 Command receiver, modified for 14-16 mc, plus usual mods., price £4 10s.—Ring Dolan, G3KZU, Oxford 63000, after 6.0 p.m.

**SALE:** K.W. Viceroy, early model with separate PSU, in excellent condition, performance equal to recent models, price £70 or near offer? (replacing with smaller equipment). RF Units 26 and 27, 15s. plus 5s. carriage. Q-Fiver, unmodified, £3 15s.

**WANTED:** KW-2000, with AC/DC PSU's, also KW-600 Linear.—Knight, G2FUU, Homefield, Upper Nazeing, Nr. Waltham Abbey, Essex. (Tel. Nazeing 2274.)

**WANTED:** Transformer 1000-0-1000v. at 200 mA; 813 heater transformer; Labgear wideband coupler unit; crystal between 12-125 and 12-150 mc.

**SALE:** Hammarlund Super-Pro, with PSU, £22. Woden UM2 mod. xformer, 50s. Crystal calibrator, 19 Set, 15s. Minimitter mod. xformer, for Class-B 807 into parallel 807, 30s.; driver xformer to match, 10s. Valves: 832, 7s. 6d.; PT-15, 10s.—Tibbert, 397 Uttoxeter Road, Derby.

**SALE:** Hallicrafters S-86 Rx, covering 538 kc to 34 mc, complete with built-in speaker, manual and transformer, price £20.—Donovan, 4 Rembrandt Drive, Northfleet, Kent.

**WANTED:** Cabinet for AR88D; also 80-metre band-spread coil-pack for HRO. **SALE:** Heathkit RA-1 receiver, 12 months old, mint condition, £27.—Quested, 26 Baldwin Road, Minster, Sheerness, Kent.

**FOR SALE:** Transmitter for 3-5 to 28 mc, 150w. **FAM/CW**, with Geloso VFO/driver, PA 2/807, modulator pair 807's, with splatter suppression and speech clipping, separate Variac-controlled PSU, fully screened and built to prevent TVI, price £30, buyer to collect.—Harbinson, 10 Deramore Park, Belfast, 9, Northern Ireland.

**AMATEUR Selling Up:** Transmitting and receiving valves, guaranteed components, at bargain prices; state wants, s.a.e. for lists.—Wood, 6 Duniwood Avenue, Bessacarr, Doncaster, Yorkshire.

**EXCHANGE:** HA-350 receiver, 100 kc calibrator, matching speaker, one week's use only, price £83 **OR** Eddystone 888A or similar Rx.—Erratt, 35 High-meadow Crescent, Kingsbury, London, N.W.9.

# IMHOFS FOR EDDYSTONE



**VISIT THE EDDYSTONE DEPARTMENT AT IMHOFS**  
**SEE, HEAR AND COMPARE ALL MODELS WORKING SIDE BY SIDE ON PERMANENT DEMONSTRATION**  
**SAME DAY DESPATCH TO ANY PART OF THE WORLD. FREE DELIVERY IN THE U.K.**  
**GUARANTEED AFTER SALES SERVICE**  
**SEND TODAY FOR FULL DETAILS**

See it now at Imhofs—the Eddystone EC10 transistorised receiver for communications work. £48 come to Imhofs for other Eddystone receivers, including **The new EB36 £54.5.7**  
**EB.35 £59.7.6**  
**EA.12 £185**  
**840.C £66.0.0**  
**940 £133**  
 —also Eddystone die-cast instrument boxes and slow motion dials. All items can be sent abroad, tax free, under our personal and direct trouble - free export schemes.

# IMHOFS

**main Eddystone retail distributors for London area**

Alfred Imhof Ltd. Dept. 11/5, 112/116 New Oxford St., London, W.C.1. MUS. 7878.

R.30

## R. T. & I. ELECTRONICS LTD.

where equipment is fully overhauled

K.W. 2000A, transceiver, with A.C. p.s.u.	£180 (40/-)
R.C.A. AR-8516-L, 18 wavebands	£175 (40/-)
Eddystone EA12 bandspread receiver	£150 (30/-)
Hallicrafters XS100, 530 kc/s.-30 mc/s.	£100 (30/-)
Hammarlund SP-600-JX, 540 kc/s.-54 mc/s.	£125 (40/-)
Eddystone 940, 480 kc/s.-30 mc/s.	£100 (30/-)
Eddystone 888A, Bandspread receiver	£85 (25/-)
Eddystone 680X, 480 kc/s.-30 mc/s.	£85 (30/-)
Heathkit Cheyenne Transmitter, Comanche Receiver, with p.s.u. and speaker	£85 (40/-)
Star, SR-600, Bandspread receiver	£72 (25/-)
G.E.W., BRT-402-E, 150-385 kc/s., 510 kc/s.-30 mc/s. with calibrator	£70 (30/-)
R.C.A. AR88D, 540 kc/s.-32 mc/s. A world beater, at Hallicrafters SX71, 560 kc/s.-34 mc/s. and 46-56 mc/s., with bandspread	£65 (30/-)
Trio JR-60-UJ, 540 kc/s.-30 mc/s. and 142-148 mc/s., band-spread and xtal cal. (NEW)	£61/19 (25/-)
Star, SR-350, Bandspread receiver	£50 (25/-)
Eddystone 840C, 550 kc/s.-30 mc/s.	£48 (25/-)
Lafayette HE-80, 540 kc/s.-30 mc/s. and 142-148 mc/s.	£46 (25/-)
GELESO G-207-DR, bandspread receiver	£45 (30/-)
R.C.A. AR88LF, 75-550 kc/s. and 1-5-30 mc/s.	£42 (40/-)
Heathkit RA-1, bandspread receiver	£35 (20/-)
Heathkit GC-1U Mk. II, 600 kc/s.-30 mc/s. with bandspread	£32 (20/-)
Trio 9R-59, 540 kc/s.-30 mc/s., with bandspread (NEW)	£34/13 (15/-)
Heathkit R6-1, 600 kc/s.-32 mc/s.	£33 (20/-)
Marconi CR100, 60-420 kc/s. and 500 kc/s.-30 mc/s., with noise limiter	£30 (30/-)
Eagle RX-60-N, 550 kc/s.-30 mc/s. with bandspread	£22 (20/-)
Lafayette HA-63, 550 kc/s.-31 mc/s.	£20 (20/-)
K.W. Electronics KW76, receiver	£18 (20/-)
<b>NEW AVOMETERS</b> , Model 7, Mk. 2, £22/5/-; Model 8, Mk. 3, £24; Model 9, Mk. 2, £24; Multimeter, Mk. 4, £9/10/-	
<b>NEW BROWN'S HEADPHONES</b> , Type "E", 120 ohms, 2K or 4K, £3/4/- (3/6). Noise excluding, high quality, electro-dynamic, low impedance, £6 (3/6).	

**NEW KW EQUIPMENT**, Vespa, with A.C. p.s.u., £120; KW2000A, with A.C. p.s.u., £220; KW201 bandspread receiver, £105.  
**NEW GREEN EQUIPMENT**, TMR-5 receivers, £35; Mark V Converters, £12.

**NEW CODAR**, AT5, 250/5, T28, PR30X, etc., in stock.  
 Our latest list of over 50 receivers, and other interesting items sent on receipt of s.a.e.

CARRIAGE for England, Scotland and Wales shown in brackets.

TERMS: C.W.O., Approved Monthly Accounts, Hire Purchase and Part Exchanges.

## R. T. & I. ELECTRONICS LTD.

Ashville Old Hall, Ashville Road, London, E.11 Tel: LEYtonstone 4986

## HALSON MOBILE ANTENNA GOING MOBILE!

Then as G3SDK/E18BK writes, I am so pleased with your Mobile Antenna system, I have recommended it to all my friends. The SWR bridge is handy too.

Complete one band system **£6/17/6** + 3/6 P. & P.  
Extra coils **£3/17/6** + 3/- P. & P.  
SWR + FSI **£4/19/6** + 3/6 P. & P.

Send for brochure

**G. D. HALL & SONS LTD.**  
2 Sefton Street, Blackpool. Telephone 20441

## WIRE SCOOP

**75,000 yds. NEW PVC HOOKUP WIRE**

Single 14/0076, 100 yd. rolls, 7/6 post paid

Single 14/0048, approx. 200 yd. coils, 7/6 post paid

*Various tracer colours*

Single 1/036, approx. 200 yd. coils, 7/6 post paid

*Colours orange or brown only*

**JUST ARRIVED.** Receivers R209, AM/FM/CW, with built-in speaker & P.S.U.; 1.0 to 20.0 Mc/s. operate from 4 volts D.C. Size 12" x 8" x 9". Untested but good condition. **£12/10/0**, carriage paid.

**ELEY ELECTRONICS**  
112 Groby Road, Glenfield, Leicester

## PRINTSET

KITS FROM  
WEST GERMANY

Used all over the world, these easily-built Printed Circuit Kits are now AVAILABLE IN THE U.K.

**NEW !!**

**ALL-TRANSISTOR  
2 METRE RECEIVER AND TRANSMITTER**

*Small enough to sit in your hand!*

In 3 kits: RX, **£4.9.11**; TX, **£5.15.0**; MOD, **£2.17.9**

**MANY OTHER KITS** — VHF — SSB — RTTY — including: —  
SSB TX kit, **£3.6.0**; El-bug kit, all-transistor, **£5.8.8**;  
DL6EQ RTTY TU kit, **£2.6.9** (BP Filter, **£2.0.4**; Tuning  
Indicator, **£1.13.2**); RTTY AFSK Oscillator kit, all-transistor,  
**£2.4.3**.

Want to know more about PRINTSET? Please ask for leaflet SP4.

**SPACEMARK Ltd.** 14 PICCADILLY,  
MANCHESTER 1  
(061-237 0817)

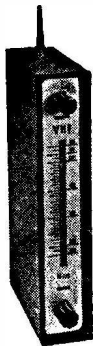

## TELECOM MK. II

**Swiss Portable Transistor Receiver**

with R.F. preselector stage, designed especially for the V.H.F. aircraft-band 118-136 Mc/s.

**£23 10s. 0d. carriage paid U.K.**

including internal loudspeaker, telescopic aerial and battery.

**BRITEC LIMITED**  
17 Charing Cross Road,  
London, WC2. 01-930-3070

SMALL ADVERTISEMENTS, READERS—*continued*

**SALE:** C.S.E. 2A10 transmitter and 2AR receiver, as new, £60.—Walker, Woodcote, Tubney, Abingdon, Berks.

**SELLING:** KT-340 general coverage receiver, as new and built to makers' handbook, price £22; buyer to collect or carriage extra.—A. Ogilton, G3VZM, Lily Ponds Cottage, Cottage Drive West, Gayton, Cheshire.

**OFFERING:** AR88D in good condition, with resprayed cabinet. Tiger T-100 150w. AM/CW transmitter, in good condition. Will deliver to 50 miles.—Miles, 28 Scotch Orchard, Lichfield, Staffs.

**SALE:** Two-element beam for 10 metres, £6. Ground-plane for 20 metres, with 30ft. low-loss coax, 50s. Command transmitter, 100-watt, with valves and unmodified, for 3.0-4.0 mc, 40s. All carriage paid.—Hughes, G3GVV, 102 Harlands Road, Haywards Heath (50961), Sussex.

**EXCELLENT VHF QTH** (22 Countries worked on two-metre band), three-bedroom detached house, with garage and garden (space for 500ft. wire), full central heating, 40 mins. Euston, price £7,300.—Ring Butcher, G3LAS, Berkhamsted 3809.

## MORSE MADE !!! EASY !!!

**FACT NOT FICTION.** If you start right you will be reading amateur and commercial Morse within a month.

Using scientifically prepared 3-speed records you automatically learn to recognise the code RHYTHM without translating. You can't help it, it's as easy as learning a tune.

For full explanatory booklet enclose 8d. in stamps to: G3HSC/P.  
45 GREEN LANE PURLEY, SURREY. UPLands 2896

## "CALLBOOK" SPRING EDITION

*Now Available*

**Limited quantity only!**

Known the world over as the CALLBOOK, this comprehensive reference lists about 270,000 licensed radio amateurs in the United States Directory and more than 120,000 in the DX Section. And... the listings grow with every issue! Over 35,000 changes are made in each quarterly issue of the United States directory alone. Each issue is an entirely new book with revised listings of new licences, names and addresses. Every amateur operator and SWL needs the latest CALLBOOK to get the most out of Amateur Radio.

**DX Listings 31/6**

**US Listings 51/6**

**The two together, covering the World, £3/18/6**

*Available only from*

**Publications Dept.,**

**SHORT WAVE MAGAZINE**

**55 Victoria Street, London, S.W.1**

**Abbey 5341**

# PETER SEYMOUR LTD.

All items ex stock at time of going to press

	£	s.	d.
CODAR ATS. AM/CW Tx. 160/80, New with P.S.U. ...	24	10	0
KW160. Built-in AE change over relay ...	15	0	0
EDDYSTONE EC10. As brand new. 540 Kc/s.-30 Mc/s. all transistor ...	38	0	0
TRAP SETS. Fully encapsulated in epoxy resin. 80-10 Mtrs. with full instructions ...	2	10	0
RF40 field strength indicators tunable 1-300 Mc/s. with antenna and earpiece ...	2	15	0
SEMI AUTOMATIC BUG KEYS. Japanese ...	4	10	0
HALLICRAFTERS SXIII. Amateur Bands only. 80-10 dual conversion. Selectable sideband, etc. ...	95	0	0
FURZEHILL. Sensitive. Valve Volt Meter, type V200 ...	18	0	0
NATIONAL NCX3 transceiver 200W. P.E.P. 80-40-20 metres with P.S.U. ...	110	0	0
SWAN 400 with 410 V.F.O., as brand new. Inc. P.S.U. ...	250	0	0
HEATH HO13. Hamscan panoramic adaptor, suitable for a wide range of I.F. frequencies. As New ...	30	0	0
SOMMERKAMP FL200B. Hardly used ...	110	0	0
HAMMARLUND HQ170. As new. 160-6 Mtrs. amateur bands ...	95	0	0
EDDYSTONE 750. 480 Kc/s.-32 Mc/s. Dual conversion ...	45	0	0
EDDYSTONE 680X. 480 Kc/s.-32 Mc/s. with "S" meter	75	0	0
Eddystone EB35 with VHF coverage. All transistor ...	40	0	0
COLLINS 75S3B. As brand new ...	265	0	0
VOLSTATIC TRANSISTOR PORTABLES. Covers L.W., M.W. and 108-135 Mc/s. A.M. 1 microvolt sensitivity. New ...	23	19	6
EDDYSTONE 740. 480 Kc/s.-30 Mc/s. ...	20	0	0

U.K. agents for COLLINS, DRAKE, SWAN, DAVCO, HY-GAIN, HEATHKIT, HAMMARLUND, HALLICRAFTERS. In fact we can supply any make of American electronic and amateur radio equipment and items.

**410 BEVERLEY RD., HULL, YORKSHIRE**

Telephone: HULL 41938 (43353 after 7.30 p.m.)

# K.W. Corner

Dartford, Kent

Dear OM,

Last month I mentioned going on a business trip to U.S.A. and Canada. I did not have much chance to operate from U.S.A. but using our Club call sign VE3KWE or my own call VE3BUS many contacts were made with the KW2000A and a 20 metre dipole made of line-cord. I was absolutely astounded to hear the Pacific stations coming into Vancouver at S9+; calls like ZK2, VR1, VR2, VR4, KH6, KW6, KG6, KM6, KJ6 and even the VK's and ZL's seemed to have a bigger punch to their signals compared with conditions in G. Operating from the eleventh floor of a Vancouver hotel I had some really exciting contacts and no TVI from the KW2000A even though I had a TV set alongside (11 TV channels, 4 of them in colour). The other side of the Rockies in Calgary, Alberta (53° below freezing), propagation conditions were completely different—their big signals seem to come from Mexico and Brazil, apart from all districts of U.S.A. Everywhere I went, visitors to our meetings were most impressed by the appearance and performance of KW equipment and in particular to the frequency stability of the KW2000S, KW Vespa and KW201. The word got around that I demonstrated frequency stability on the KW2000A and KW201 by tuning in to a sideband station and then lifted the equipment 8-9 inches above the table to let it drop without de-tuning the signal. Consequently I was asked more than a dozen times to exhibit this potential and of course I was confident and proud to do so. I am only sorry that I managed to work about half-a-dozen British Isles stations—conditions for Europe were not at all good during the whole trip. If you are thinking of buying KW equipment in the near future, please contact us soon, as a great deal of our output will be finding its way West—then there is South Africa and the EFTA countries all of whom have recently discovered the qualities of the latest KW models. We try to maintain stocks of all our advertised equipment and adjust our production accordingly. Next month I hope to tell you about some new additional lines from the KW production line.

Yours faithfully,  
**ROWLEY SHEARS,**  
 Managing Director, G8KWV,  
**KW ELECTRONICS LIMITED,**  
 1, Heath Street, Dartford, Kent.

## MAPS

### AMATEUR RADIO MAP OF WORLD

Mercator Projection — Much DX Information — In Colour. Second Edition, 8s. 6d.

### GREAT CIRCLE MAP

(Black and White only) 5s. 6d. (See S.W.M. page 661, Jan. '67)

### DX ZONE MAP

(New edition) 14s. 9d. (See S.W.M. page 643, Jan. '67)

### RADIO AMATEUR MAP OF THE U.S.A. AND NORTH AMERICA

State boundaries and prefixes, size 24in. by 30in., paper. 7s. 0d.

### RADIO AMATEUR'S WORLD ATLAS

In booklet form, Mercator projection, for desk use. Gives Zones and Prefixes, 10s. 9d.

## CALL BOOKS

"G's" only 6s. 7d.

### SPRING EDITION

"DX Listings," 31/6. "U.S. Listings," 51/6. The two together, covering the World, £3/18/6.

## LOG BOOKS

### A.R.R.L.

(Spiral bound), 9s. 6d.

### A.R.R.L.

(Minilog) 4in. by 6in., 5s. 6d.

### R.S.G.B.

6s. 6d.

All prices inclusive of postage and packing

## MORSE COURSES

G3HSC Rhythm Method of Morse Tuition

Complete Course with three 3 speed L.P. records with books ...	84/-
Beginner's Course with two 3 speed L.P. records with book ...	60/6
Single, 12" L.P. Beginner's with book	50/-
Single, 12" L.P. Advanced with book	50/-
Three speed simulated GPO test. 7in. d.s. E.P. record ...	11/6

Available from **SHORT WAVE MAGAZINE**

Publications Dept., 55 Victoria Street, London S.W.1 • Abbey 5341 (Nearest Tube Station, St. James's Park)



# The first choice of Radio Amateurs throughout the World

## AMERICAN HEATHKIT SSB EQUIPMENT "The world's most advanced Amateur Equipment"

Prices quoted are Mail Order and include duty, carriage, (Retail Prices carry a small surcharge)

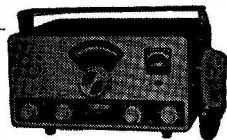

Transceiver HW-12A



Receiver SB-301E



Transmitter, SB-401E

**FILTER-TYPE SINGLE BAND SSB TRANSCIVER, Models.** For the 80, 40, or 20 metre bands. 200 W. P.E.P. input TX. 1  $\mu$ V sensitivity RX. Employs easy-to-build printed board techniques, with pre-aligned circuits. Power Req.: 800v. D.C. at 250 mA., 250v. D.C. at 100 mA., 125v. D.C. at 5 mA, 12v. A.C. or D.C. at 3-75A.

Models HW-12A (80m.) £53. 10. 0 Kit  
HW-32A (20m.) £53. 10. 0 either Kit

GH12. Push Talk Microphone £3. 10. 0 Assembled

**LATEST MONITOR SCOPE, Model SB-610E.** Displays waveforms of transmitter output from 5 W. to 1 kW, up to 50 Mc/s. Can also be used to indicate P.E.P. Will monitor received signal (I.F. up to 6 Mc/s.). Built-in two-tone generator. Power Req.: 110v. or 240v. A.C. £37. 2. 0 Kit

**2 METRE TRANSCIVER, HW-30.** Input 5 watts c.c. Tunable regenerative Rx. Compact size. 12v. power supply available. £23. 10. 0 Kit

**80-10m. TRANSCIVER Model SB-101.** Send for full details. £165. 0. 0 Kit

Fully transistorised **ELECTRONIC AUTO KEYS, Model HD-10.** Speed range 15 to 60 w.p.min. £21. 0. 0 Kit

**AMATEUR BANDS 80-10m. RECEIVER, Model SB-301E.** This de-luxe receiver offers unsurpassed value to the Radio Amateur. Of advanced concept, employing up-to-date design and construction techniques, its ultimate specification ensures unparalleled performance. Full specification and details on request. Weight 22lb. Power Req.: 115/230v. A.C. 50/60 c/s. 50 watt. Size: 17 $\frac{3}{8}$ " x 6 $\frac{3}{8}$ " x 13 $\frac{3}{8}$ ". £125. 0. 0 Kit (Less speaker)

**AMATEUR TRANSMITTER, Model SB-401E.** This transmitter is designed for "lock-in" facility with the SB-300E. A self-powered filter type Tx covering the "Amateur" bands, 80 to 10 m. with a P.E.P. of 180 watts. Weight 33lb. Power Req.: 115/230v. A.C. 50/60 c/s. Size: 14 $\frac{1}{2}$ " x 6 $\frac{3}{8}$ " x 13 $\frac{3}{8}$ ". £140. 0. 0 Kit  
Crystal Pack SBA-401-1 £15. 5. 0 extra

**LINEAR AMPLIFIER, Model SB-200.** Covers 80-10m. 1200 W. P.E.P. input SSB—1000 W. C.W. Solid state power supply. 120 or 240v. A.C. £107. 10. 0 Kit

**THE WORLD'S SMALLEST KILOWATT LINEAR.** The Heathkit, Model HA-14. 80-10m. Provides 1000 W. P.E.P. input power. Size only 3 $\frac{1}{8}$ " x 12 $\frac{1}{8}$ " x 10" deep. Weight 9lb. Power supply available. £49. 10. 0 Kit

## Please send for the FREE British Heathkit catalogue



**AMATEUR BANDS RECEIVER, Model RA-1.** Covers all amateur bands 10-160 metres. Half-lattice crystal filter at 1.6 Mc/s. I.F. Provision for fixed, portable or mobile uses. Switched USB and LSB for SSB. £39. 6. 6 Kit £52. 10. Assembled

**OPTIONAL EXTRAS.** Crystal Calibrator CL-1 £4. 12. 0 Kit. Loudspeaker Cabinet SG-4 £1. 9. 6. Loudspeaker £1. 4. 5 incl. P.T

**AMATEUR TRANSMITTER, Model DX-40U.** From 80-10 m. Power input 75 W., CW., 60 W. peak, C.C. phone. Output 40 W. to aerial. £29. 19. 0 Kit £41. 8. 0 Assembled

**AERIAL TOWER, Model HT-1.** Strong steel construction. Height 32ft., self supporting. 3ft. x 3ft. at base.

HT-1G (galv. finish) Kit £43. 15. 0  
HT-1 (red oxide finish) Kit £37. 15. 0

**"MOHICAN" GENERAL COVERAGE RECEIVER, Model GC-1U.** In the forefront of design with 4 piezo-electric transistors, 10 transistors, variable tuned B.F.O. and Zener diode stabiliser. £37. 17. 6 Kit £45. 17. 6 Assembled

Suitable Battery Eliminator, Model UBE-1 £2. 17. 6 Kit

**REFLECTED POWER METER, Model HM-11U.** Indicates Antenna/Transmitter match. £8. 10. 0 Kit £10. 15. 0 Assembled

**HIGH-SENSITIVITY GENERAL COVERAGE RECEIVER, Model RG-1.** A high performance, low cost receiver for the discriminating short-wave listener. Frequency coverage from 600 Kc/s. to 1.5 Mc/s. and 1.7 Mc/s. to 32 Mc/s. Send for details. £39. 16. 0 Kit £53. 0. 0 Assembled



**AMATEUR TRANSMITTER, Model DX-100U.** Covers all amateur bands from 160-10 metres, 150 watts D.C. input. Own power supply. £81. 10. 0 Kit £106. 15. 0 Assembled

**Q MULTIPLIER KIT, Model GPM-1.** May be used with receivers having 450-470 Kc/s. I.F. Provides either additional selectivity or signal rejection. Self powered. Model GPM-16 for 1.6 Mc/s. I.F. Either model £8. 10. 0 Kit £12. 14. 0 Assembled

**GRID-DIP METER, Model GD-1U.** Continuous coverage 1-8 to 250 Mc/s. Self-contained. £11. 9. 6 Kit £14. 19. 6 Assembled

**VARIABLE FREQ. OSCILLATOR, Model VF-1U.** Calibrated 160-10m. fund. outputs on 160 and 40 m. Ideal for our DX-40U and similar TX. £10. 17. 6 Kit £15. 19. 6 Assembled

To DAYSTROM Ltd., Dept. SW-5 Gloucester, England

Please send me

Tel. Glos. 20217

FREE BRITISH HEATHKIT CATALOGUE (Yes/No)  
American Heathkit Catalogue I/- (Yes/No)

Full details of model(s) .....

NAME .....

(Block Capitals)

ADDRESS .....

SW5

## HEATHKIT in LONDON

Demonstrations of Heathkit models given at the LONDON Centre, 233 Tottenham Court Road, W.1. Tel: 01-636 7349. See and hear the kit of your choice. Goods may be purchased for taking away, or orders can be placed for Mail Order despatch from our Gloucester factory.

DO COME AND SEE US WHEN IN TOWN